

ARROW DETAILS FOR E5-3, E5-3a, E5-4 and E5-4a

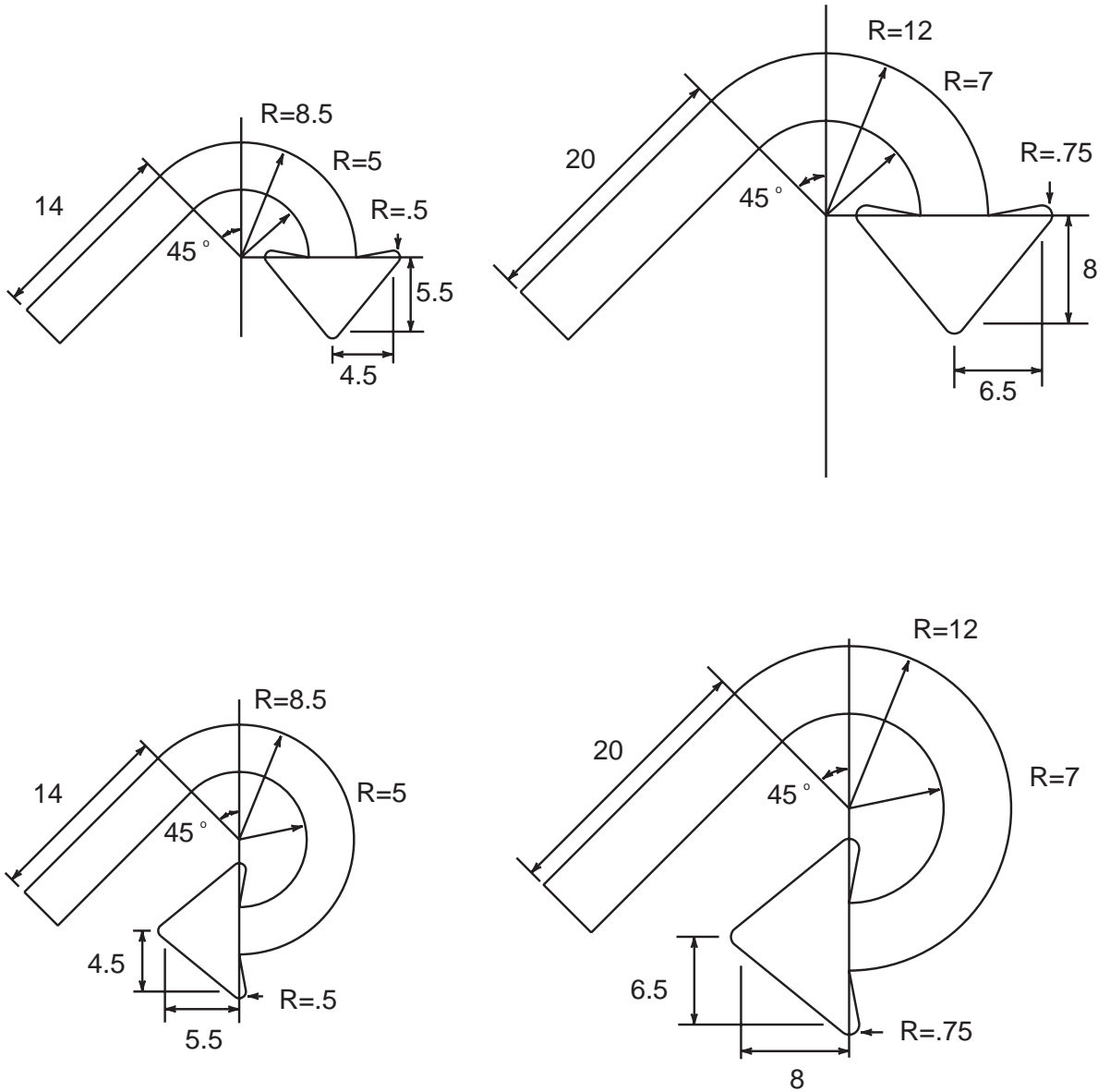

STANDARD ARROW DETAILS

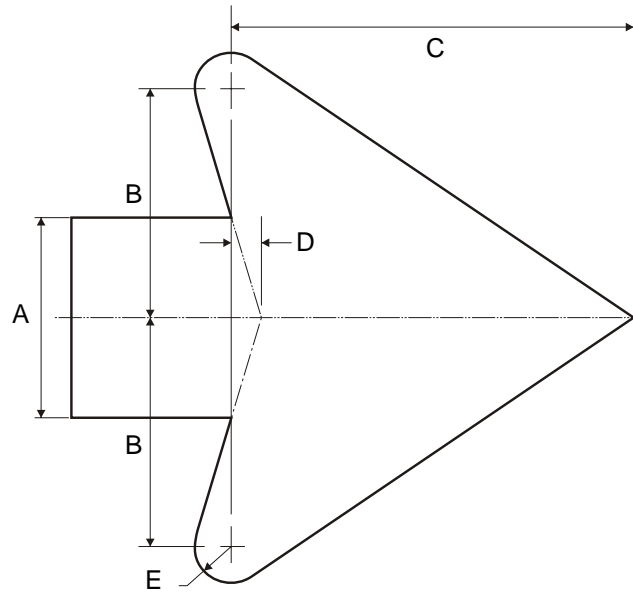

A	B	C	D	E
.28	.322	.568	.04	.056
.68	.78	1.38	.105	.136
.75	.875	1.5	.125	.15
1.125	1.3	2.284	.175	.225
1.375	1.58	2.8	.213	.275
1.5	1.75	3.063	.25	.313
1.6	1.8	3.188	.25	.313
1.625	1.875	3.313	.25	.313
1.75	2	3.55	.27	.35
2	2.313	4.313	.313	.375
2.25	2.625	4.5	.375	.438
2.5	2.875	5.063	.375	.5
2.625	3	5.25	.375	.5
2.75	3	5.563	.438	.563
3	3.5	6.125	.438	.563
3.125	3.625	6.375	.5	.625
3.25	3.75	6.625	.5	.625
3.313	3.813	6.688	.5	.688
3.375	3.875	6.75	.5	.688
3.5	4	7.125	.563	.688
3.625	4.168	7.358	.563	.72
3.75	4.313	7.625	.563	.75

A	B	C	D	E
4	4.625	8.125	.625	.813
4.063	4.75	8.25	.625	.813
4.125	4.75	8.37	.625	.813
4.25	4.875	8.625	.625	.813
4.375	5	8.875	.688	.875
4.5	5.188	9.125	.688	.875
4.75	5.438	9.625	.75	1
4.875	5.625	9.875	.75	1
5	5.75	10.125	.75	1
5.25	6	10.625	.813	1.063
5.375	6.125	10.813	.813	1.1
5.5	6.375	11.125	.875	1.125
5.75	6.625	11.688	.875	1.125
6	6.875	12.188	.938	1.188
6.5	7.5	13.188	1	1.625
7	8	14.188	1.063	1.375
7.5	8.625	15.188	1.125	1.5
8	9.188	16.25	1.25	1.625
8.25	9.5	16.75	1.28	1.65
8.5	9.75	17.25	1.313	1.75
8.75	10	17.75	1.375	1.75
9	10.35	18.25	1.395	1.8
10	11.5	20.3	1.563	2

TYPE "A", TYPE "B" AND DOWN (UP) ARROWS

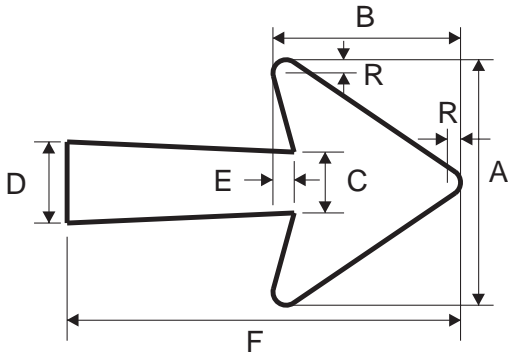

TYPE "A"

	A	B	C	D	E	F	R
A-1	15.125	11.5625	3.75	5	1.3125	24.25	.8125
A-2	18.25	14	4.5	6	1.5	29.25	.75
A-3	22.25	17	5.375	7.125	1.75	35.625	1

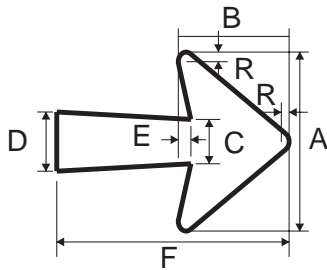

TYPE "B"

	A	B	C	D	E	F	R
B-1	14.25	9.8125	3.375	4.5	1.3125	17.25	.75
B-2	17.5	11.75	4.375	5.625	1.5	20.25	.875
B-3	21.875	14.25	5	6.75	1.75	25	1
B-4	8.4375	5.4375	2.3125	2.9375	.625	9.5625	.5

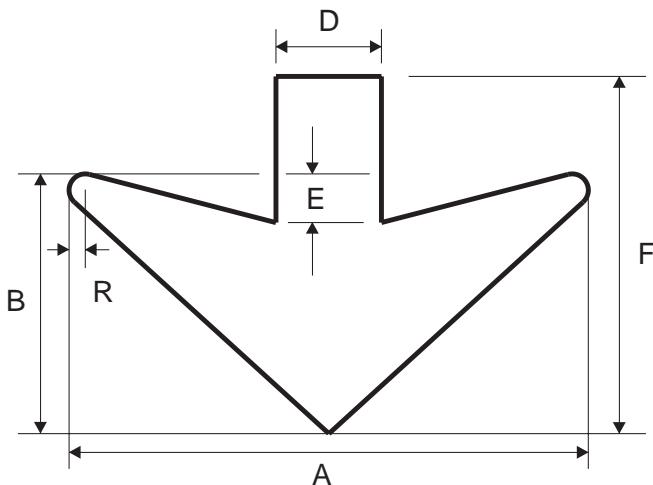

DOWN and/or UP ARROW

A	B	C	D	E	F	R
32	16		6.5	3	22	1
29	14.5		scale	scale	20	scale
23.25	11.625		scale	scale	16	scale
20.25	11.25		6.5	1.375	13.5	.75
14	7		4.5	.875	9.75	.5
15.25	8.5		5	scale	10.25	scale

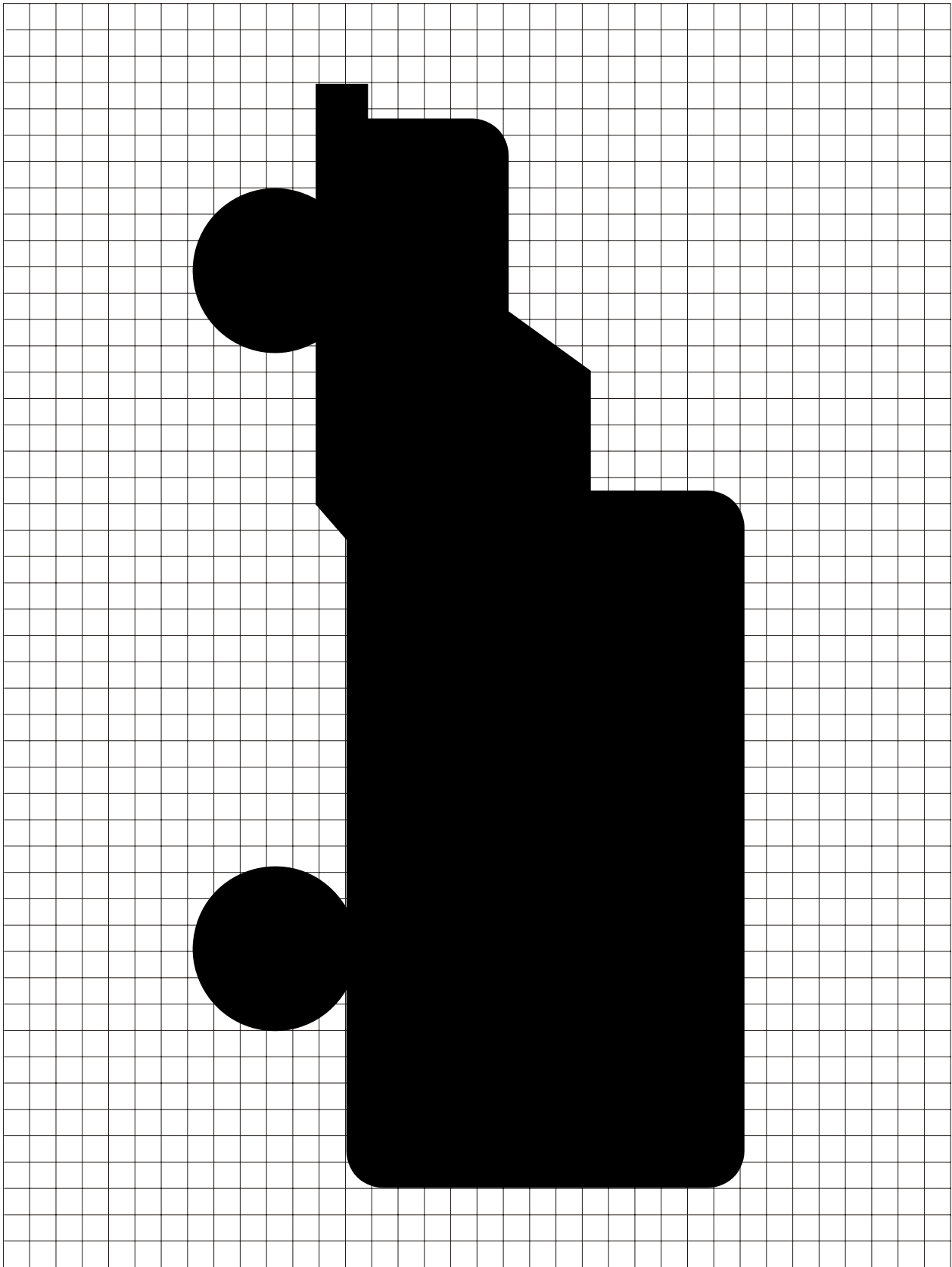

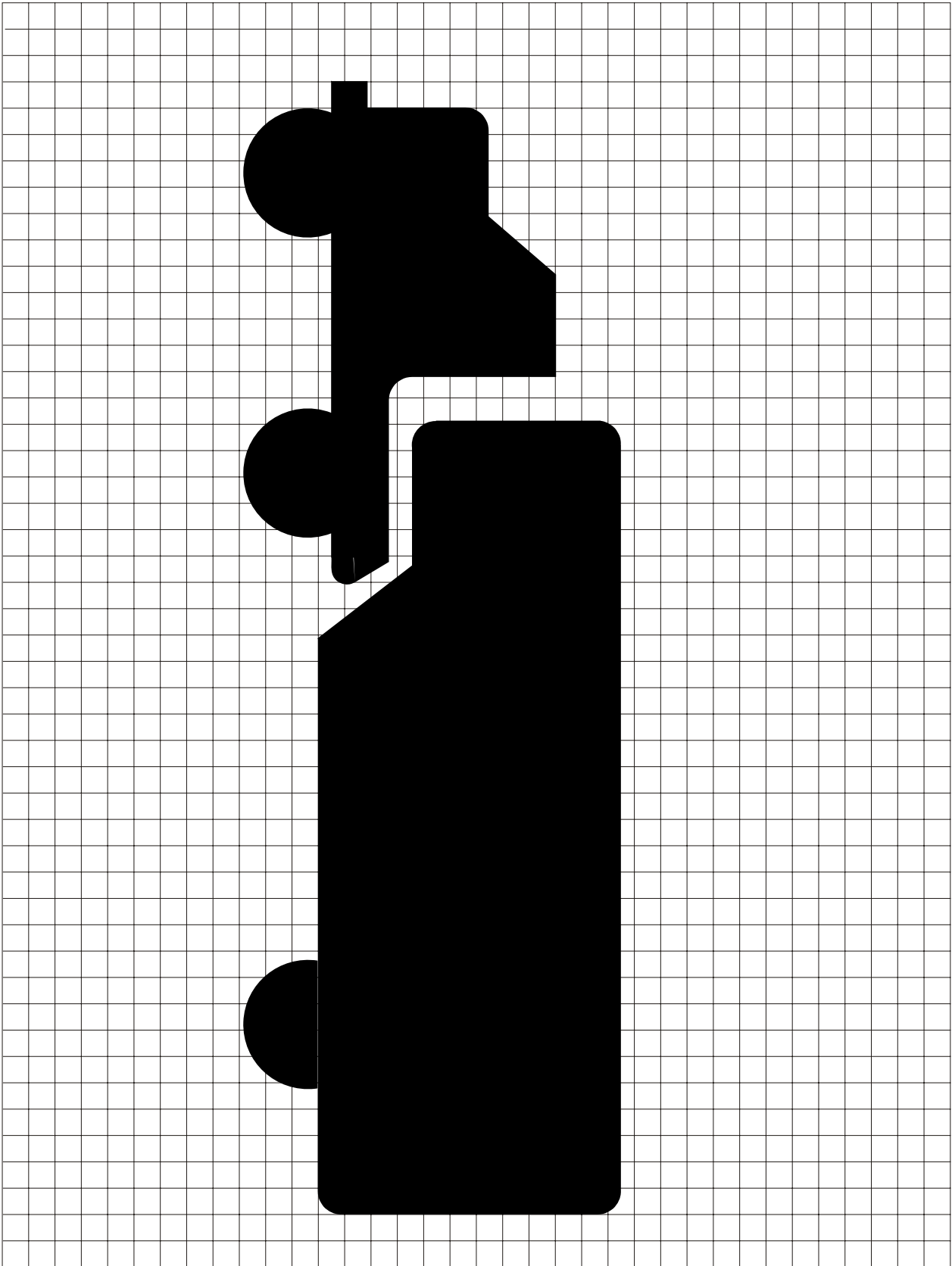

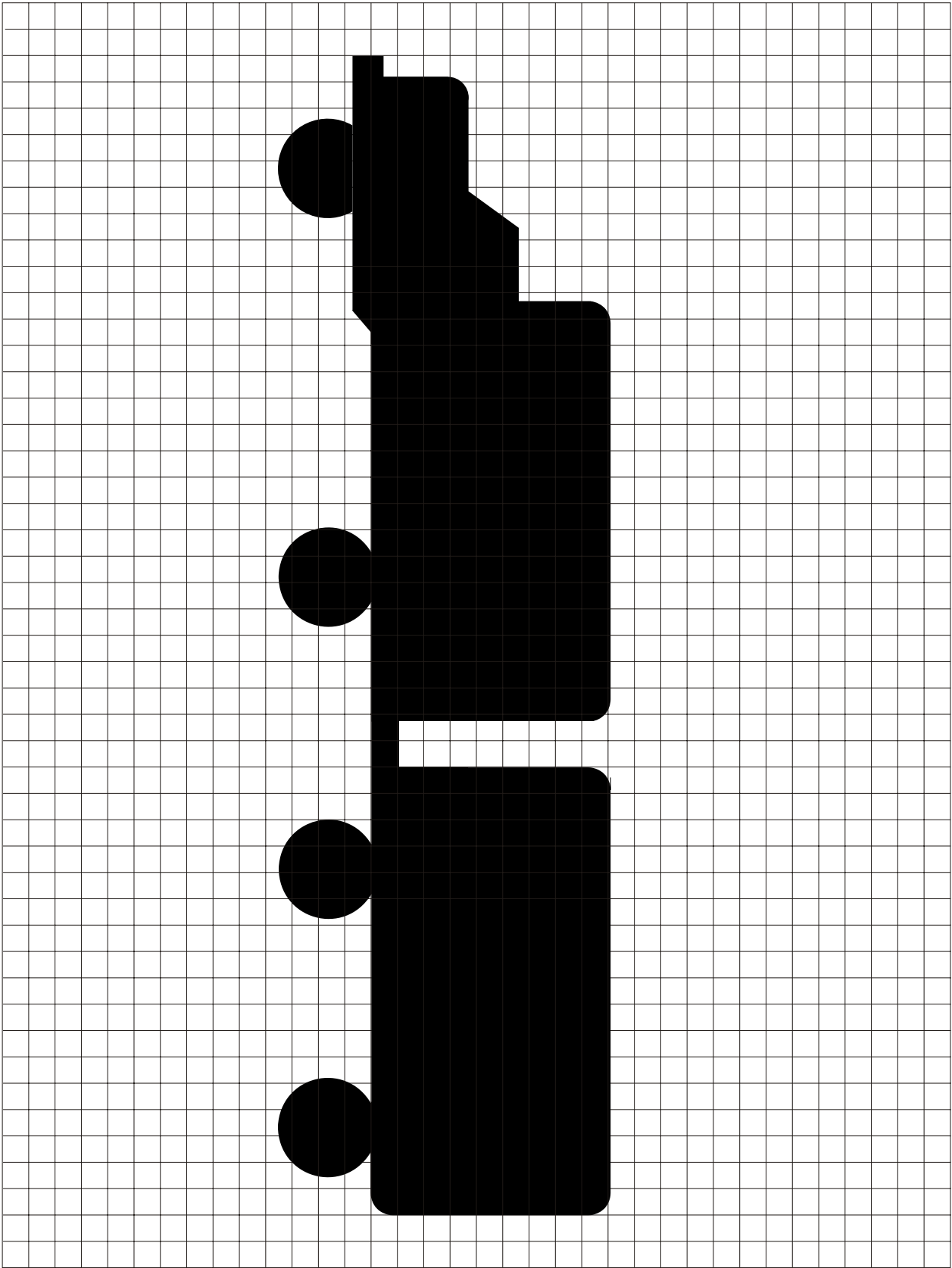

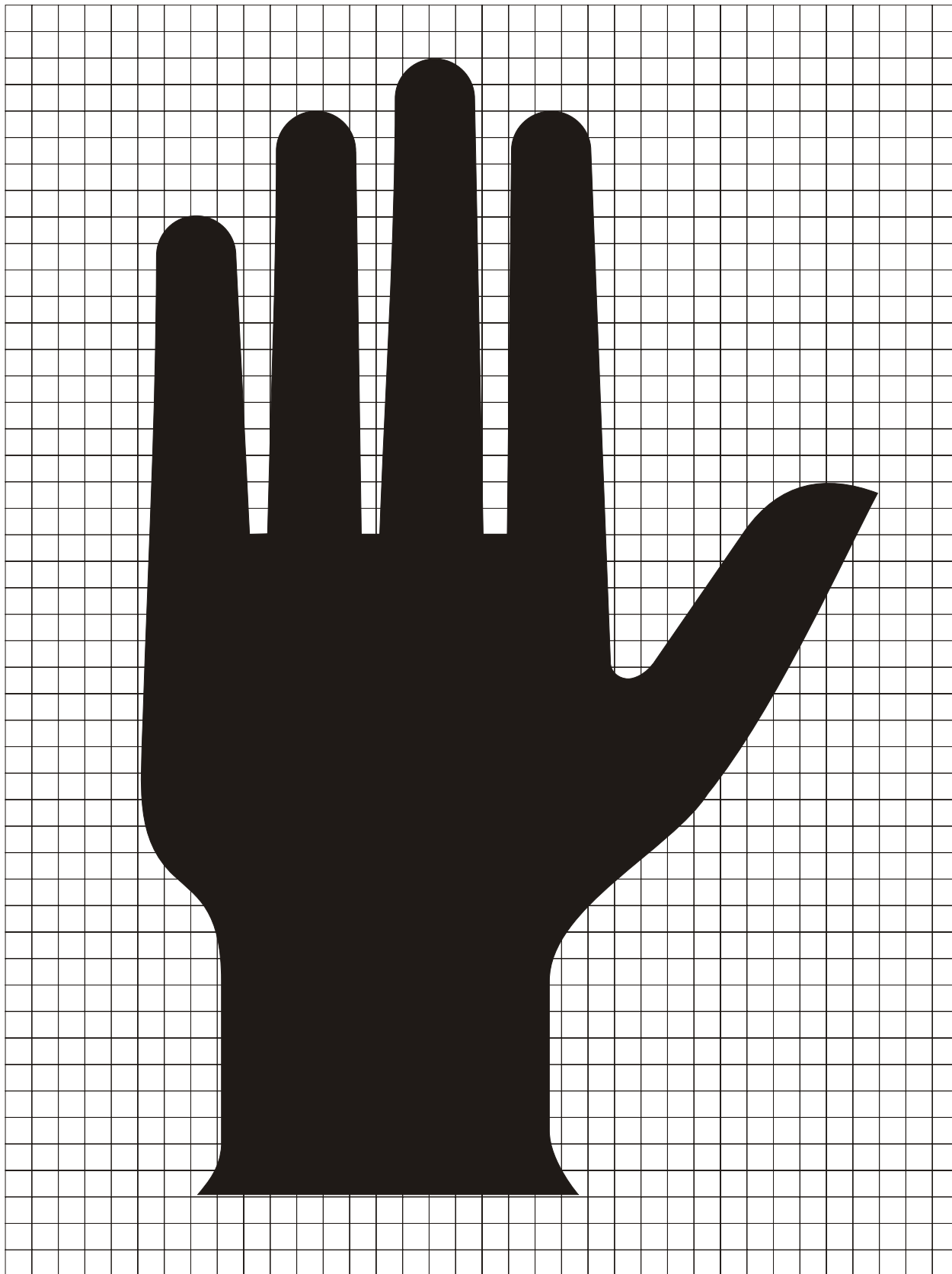

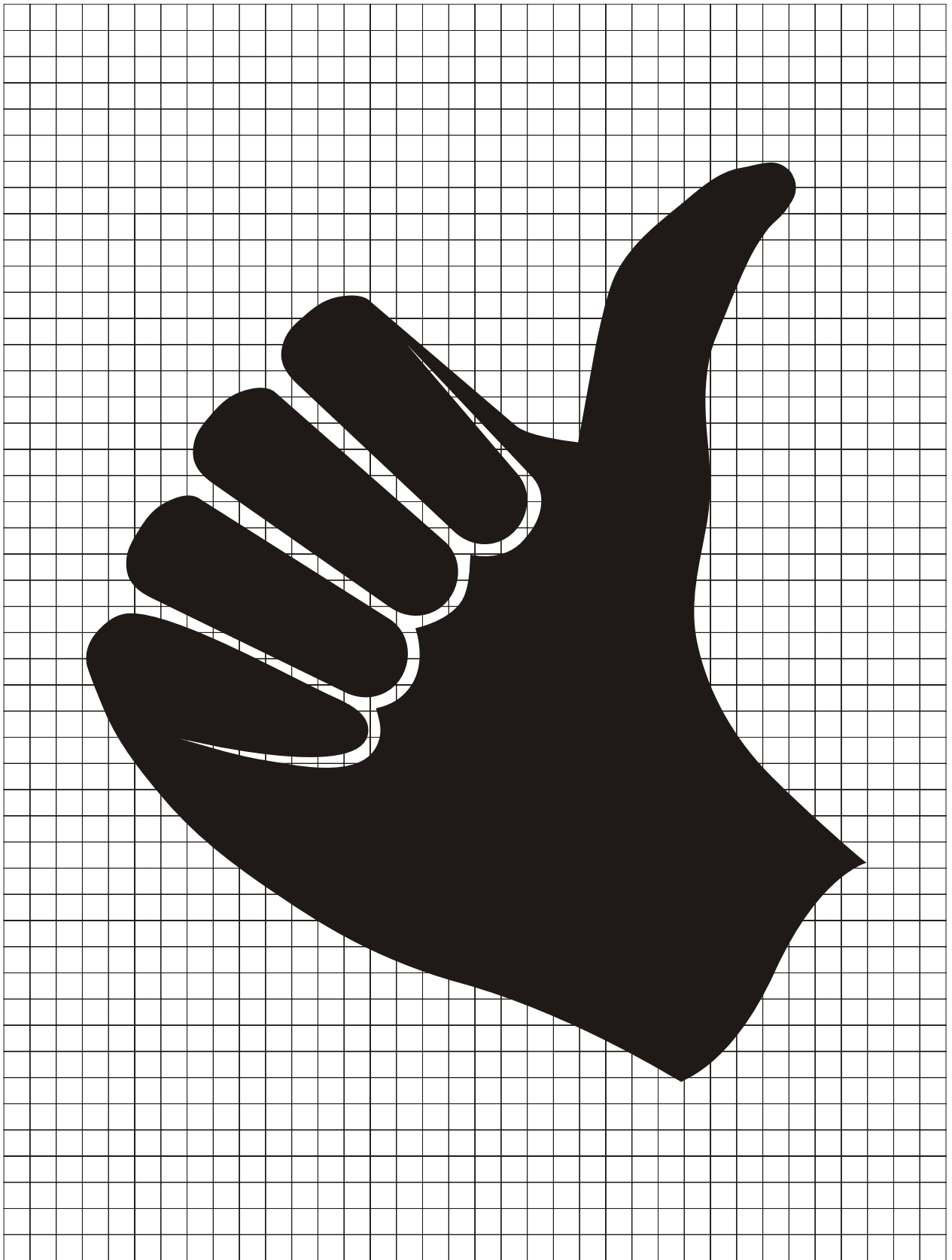

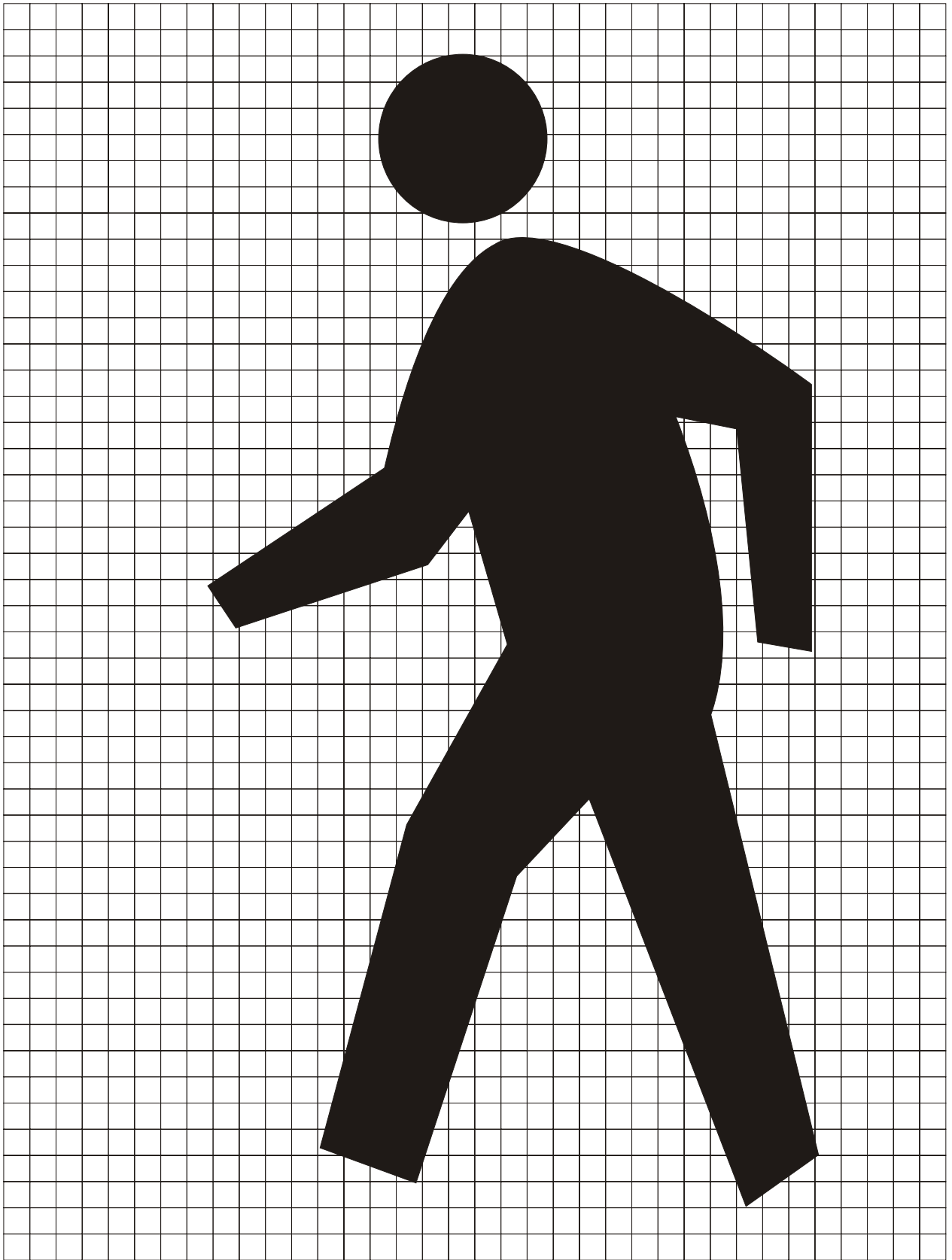

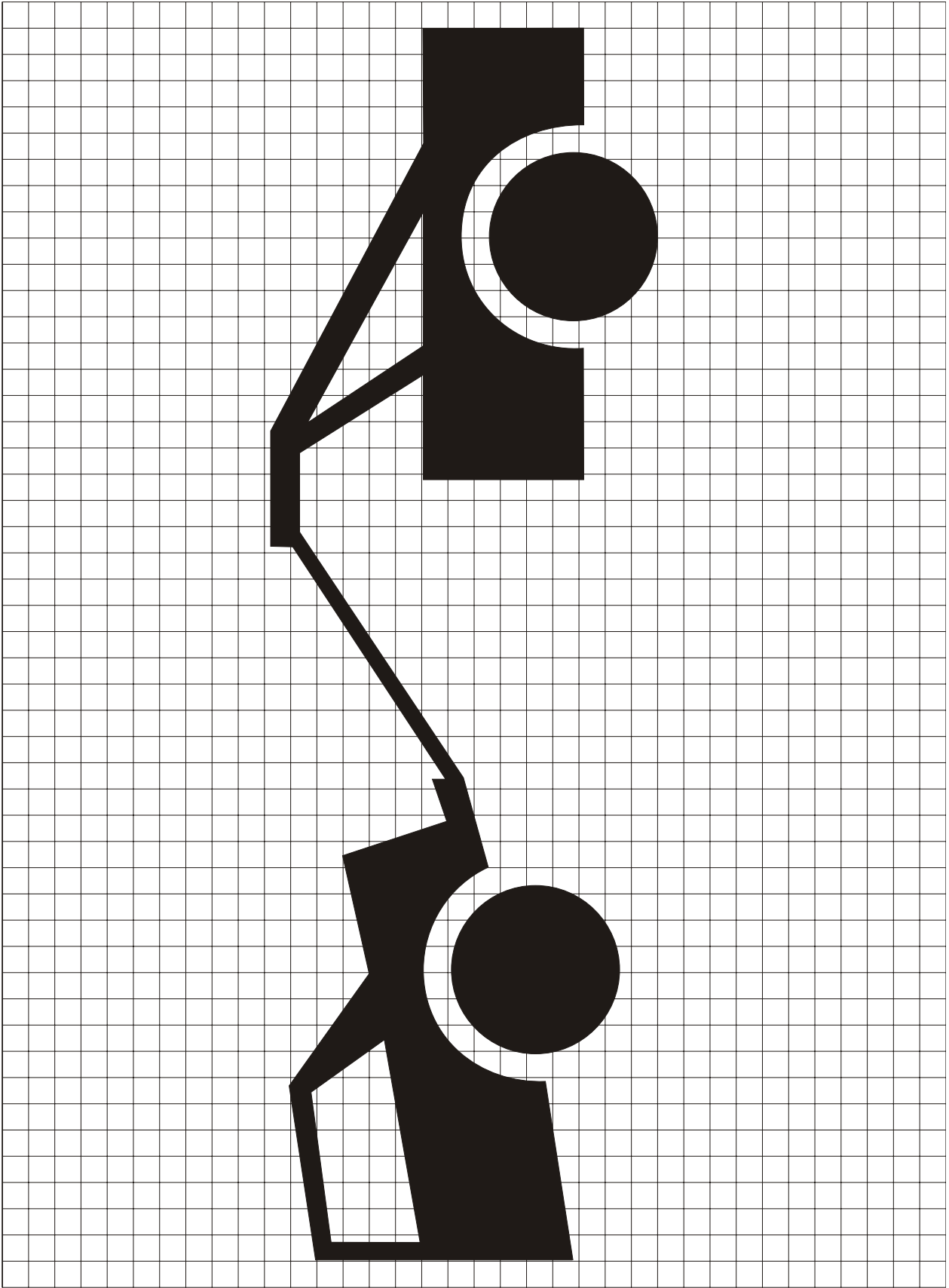

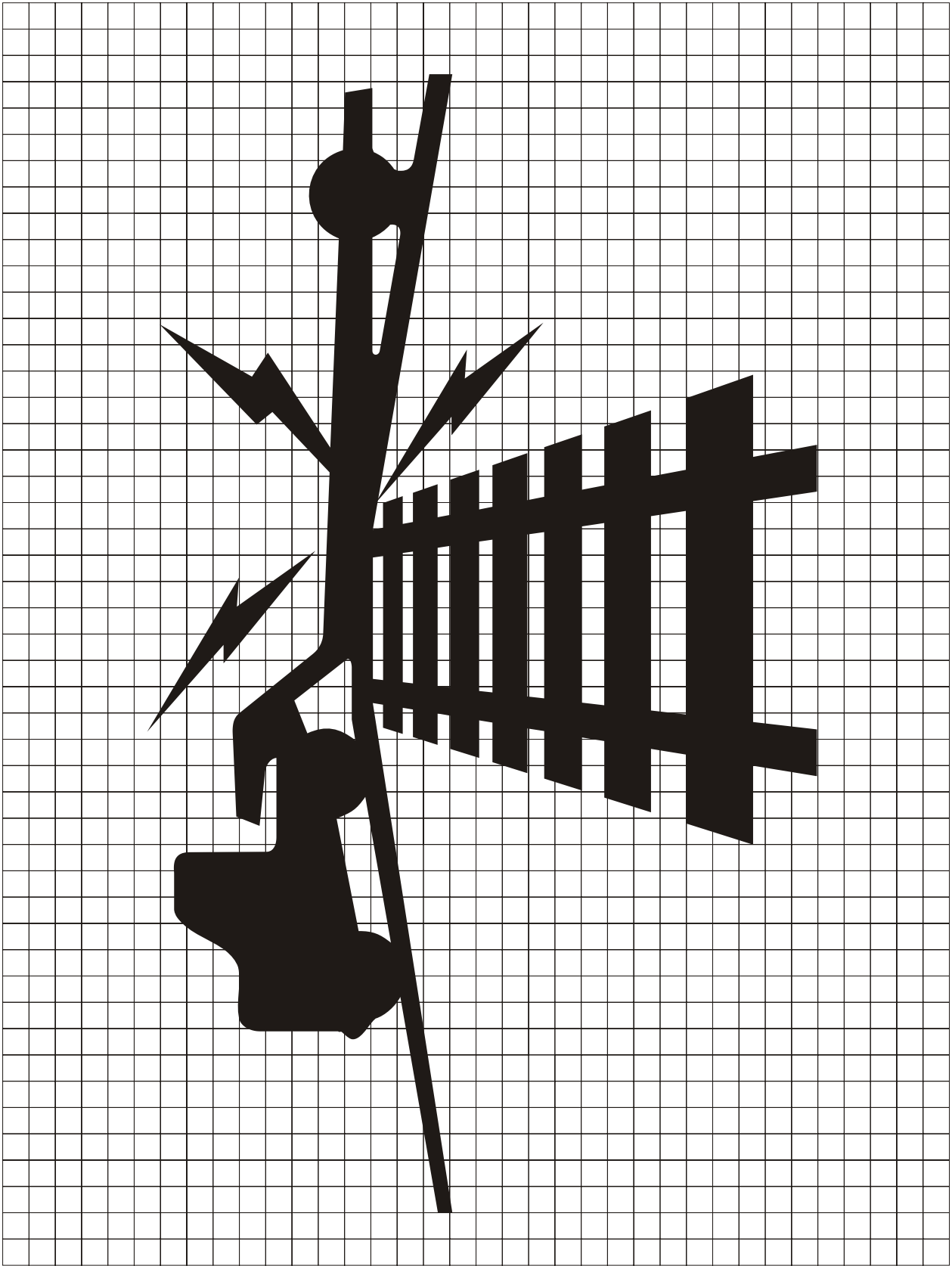

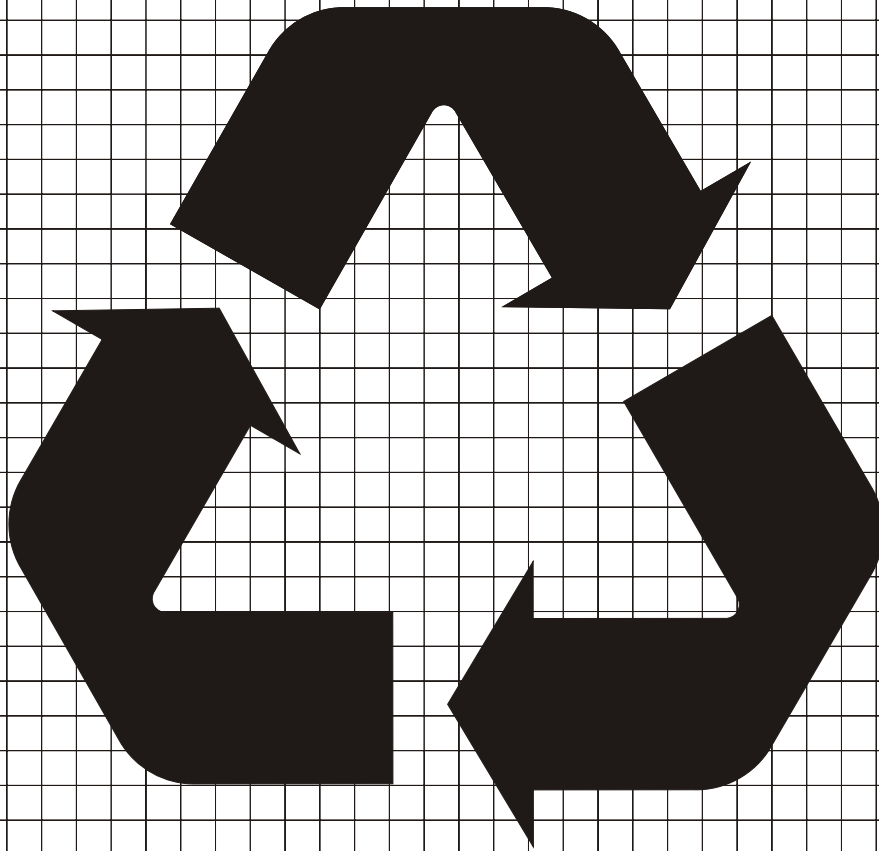

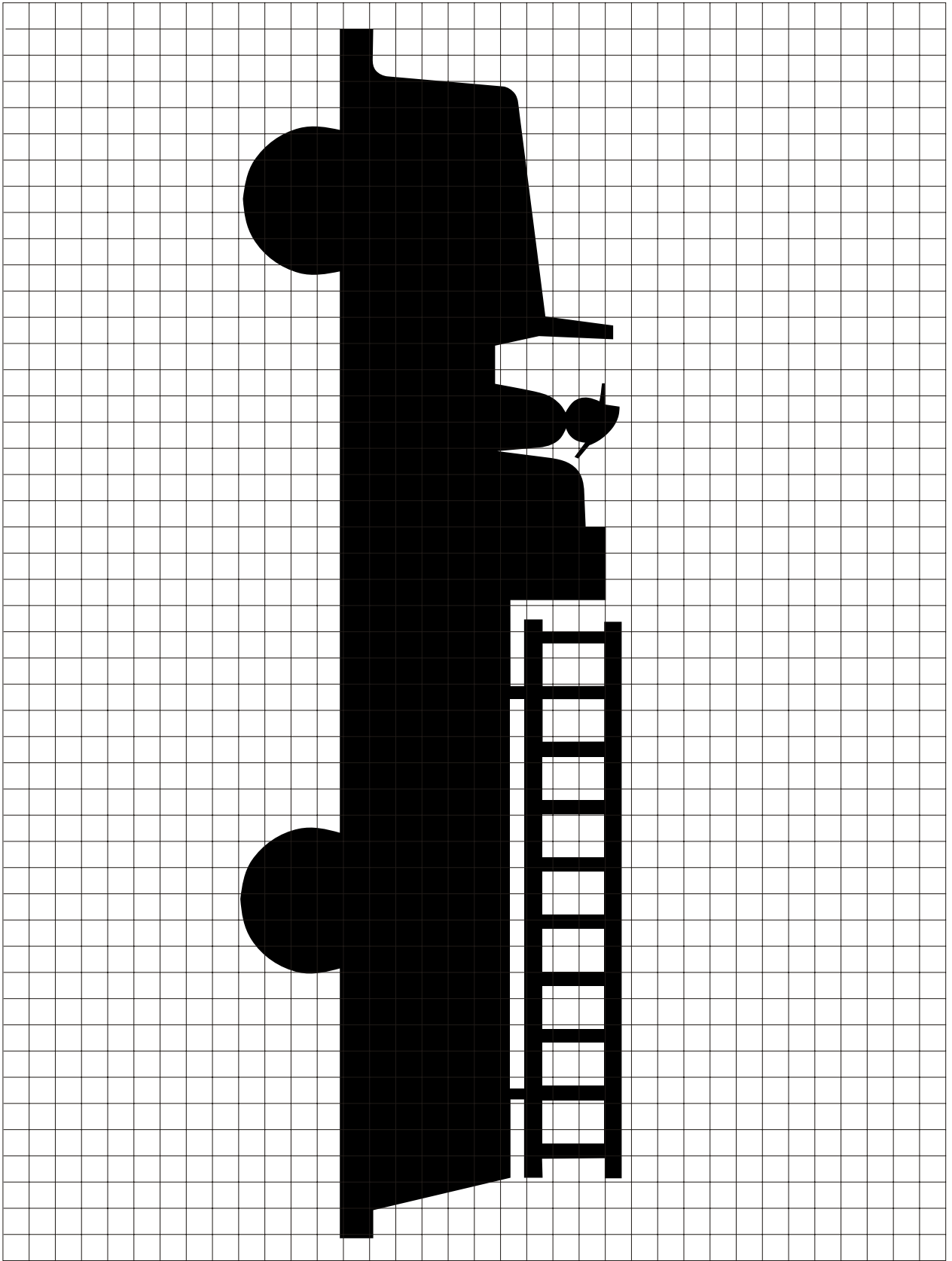

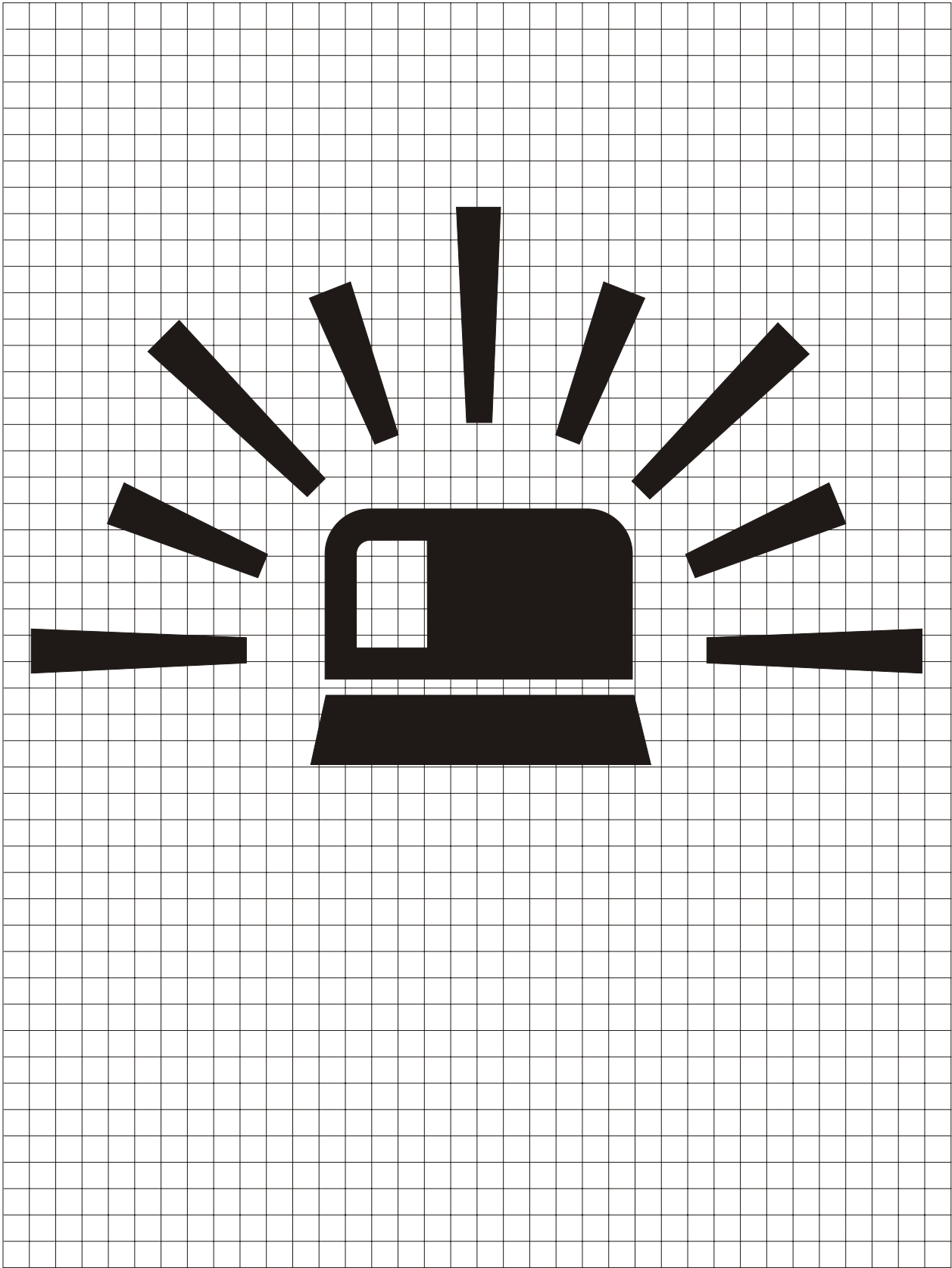

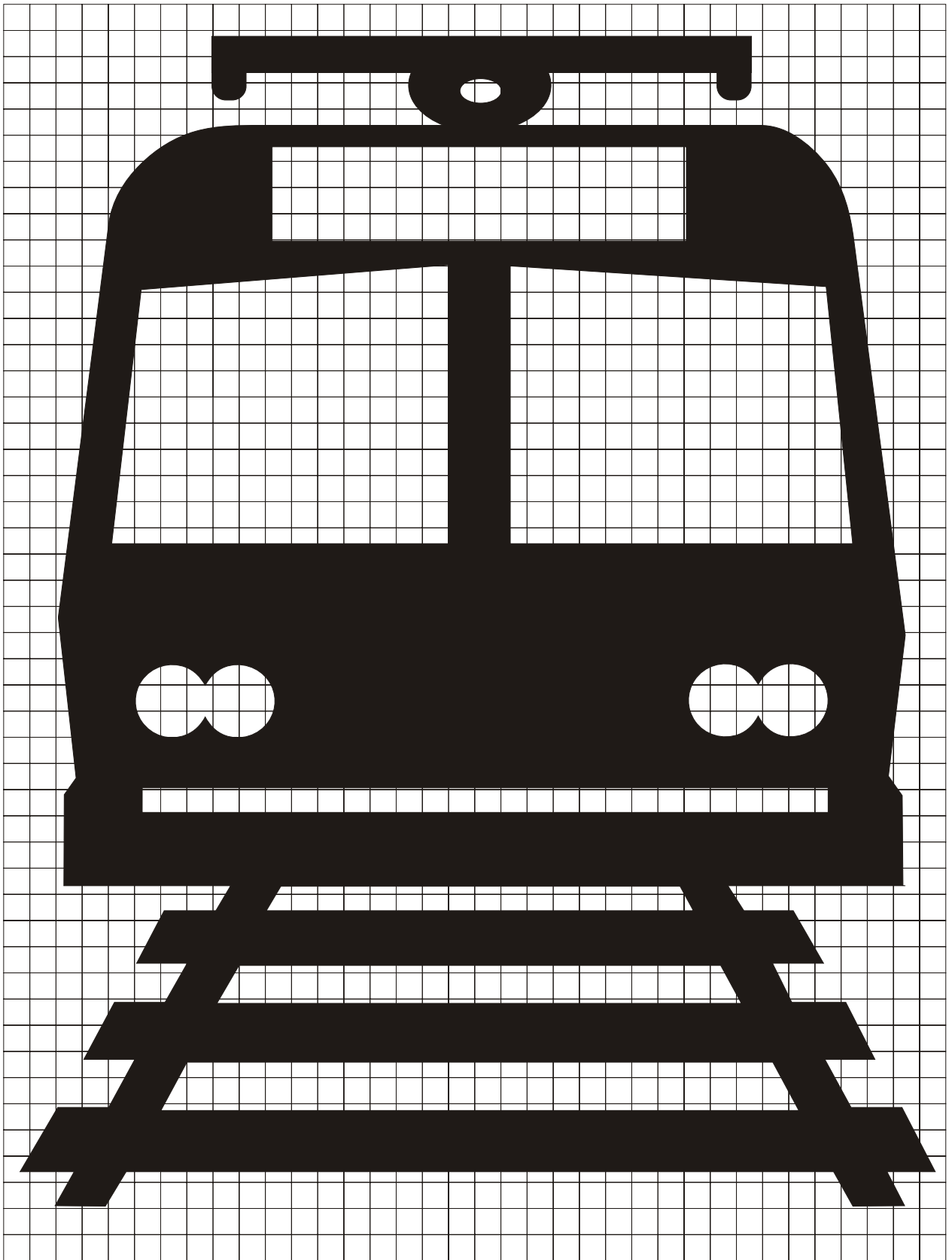

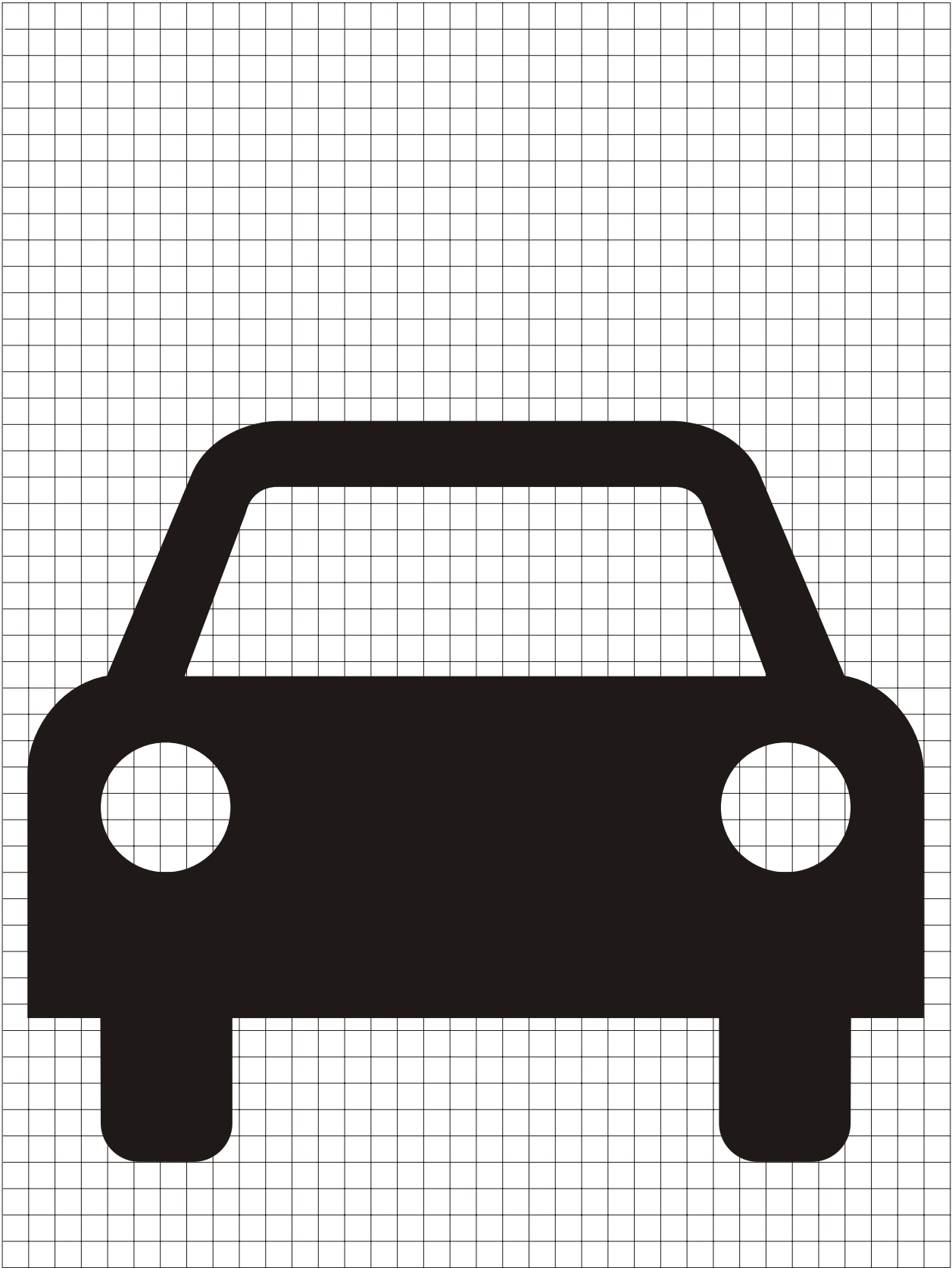

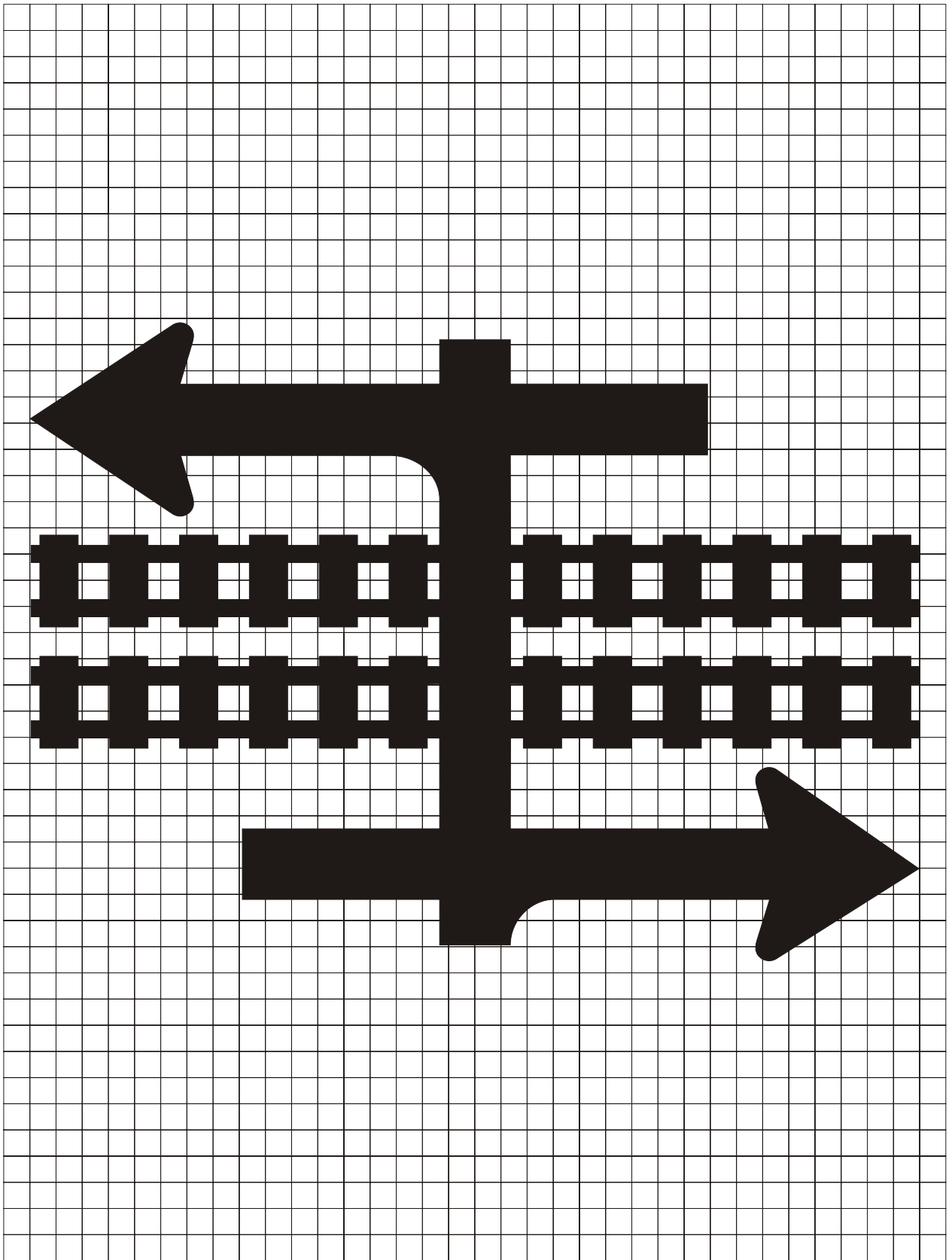

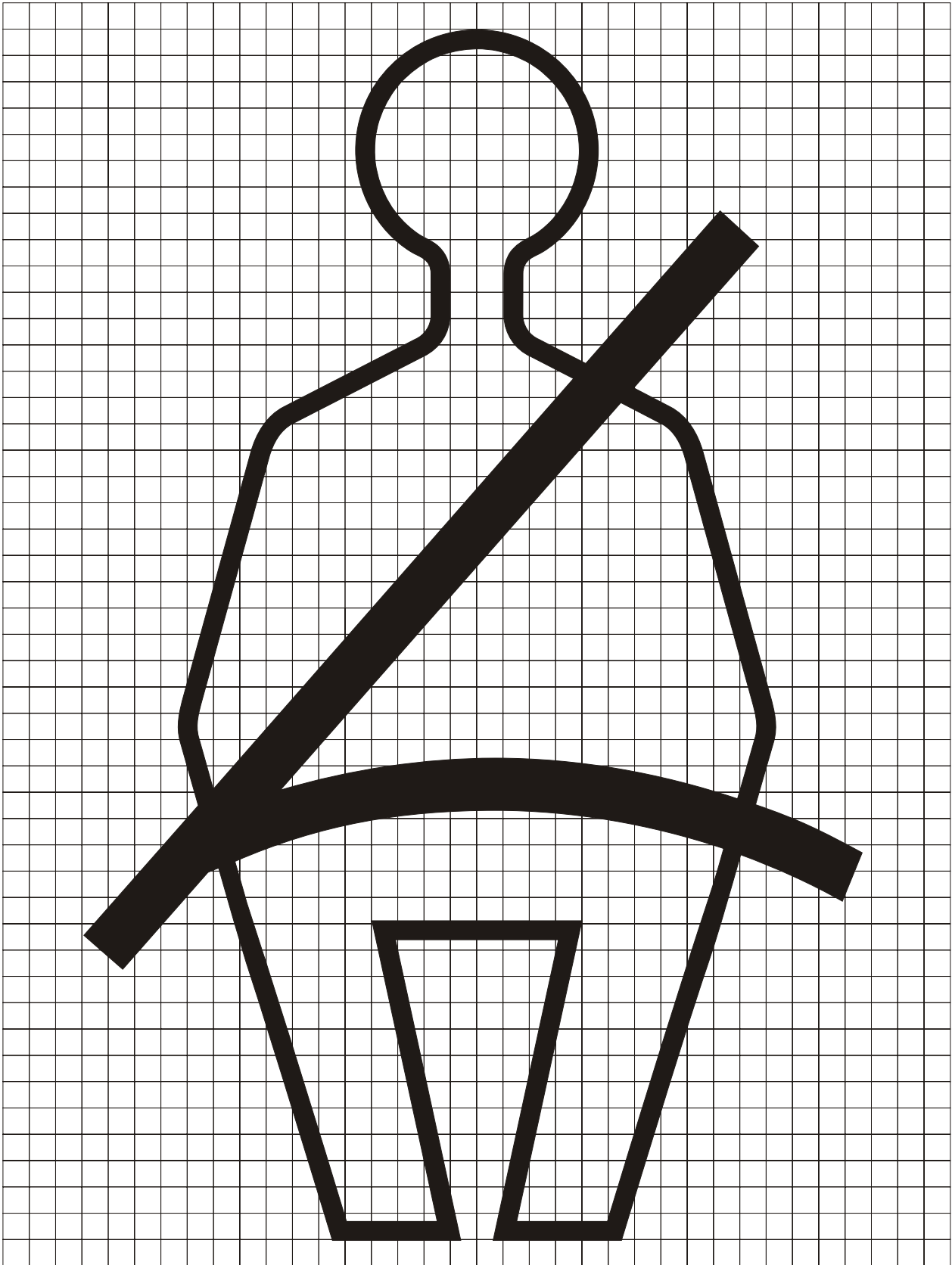

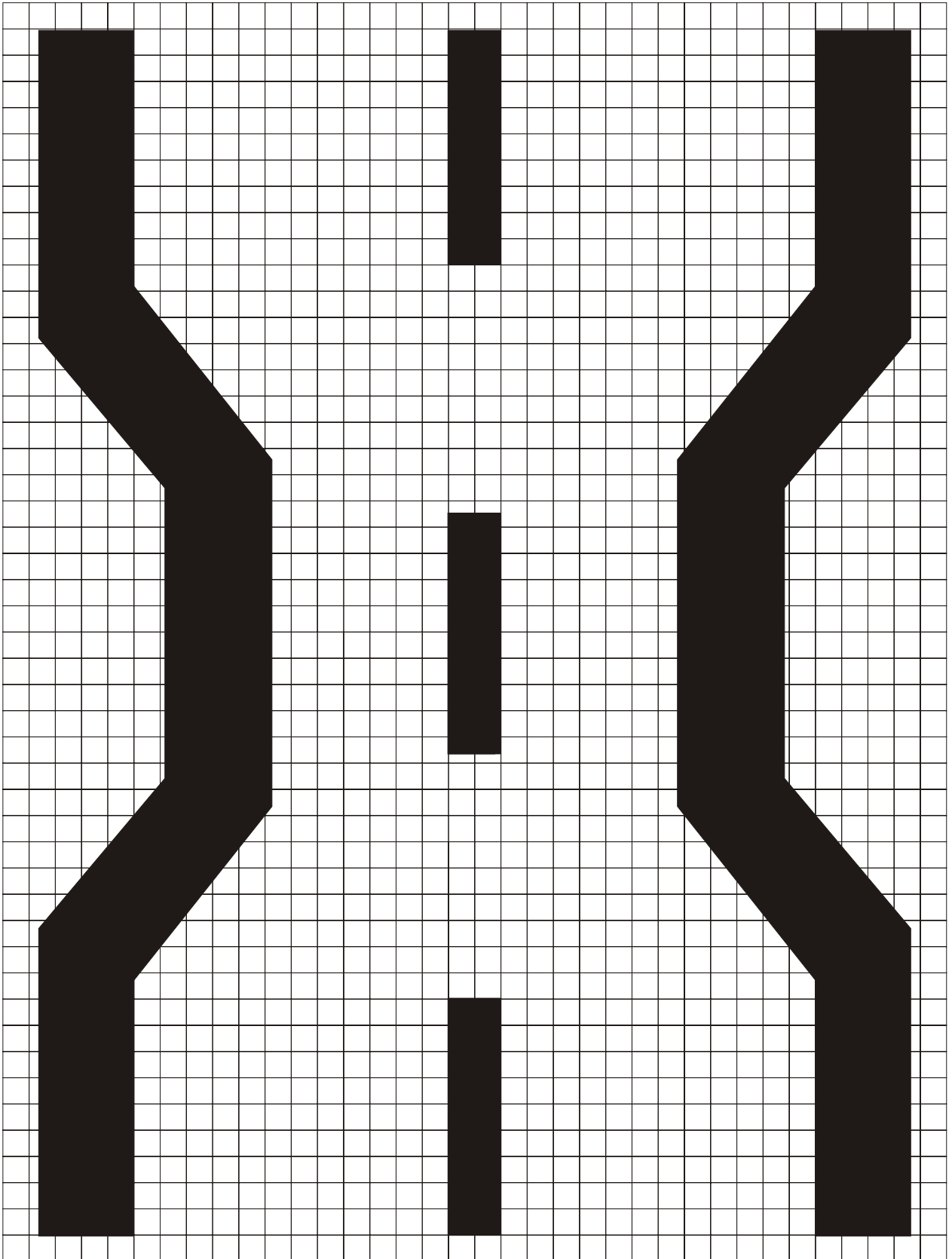

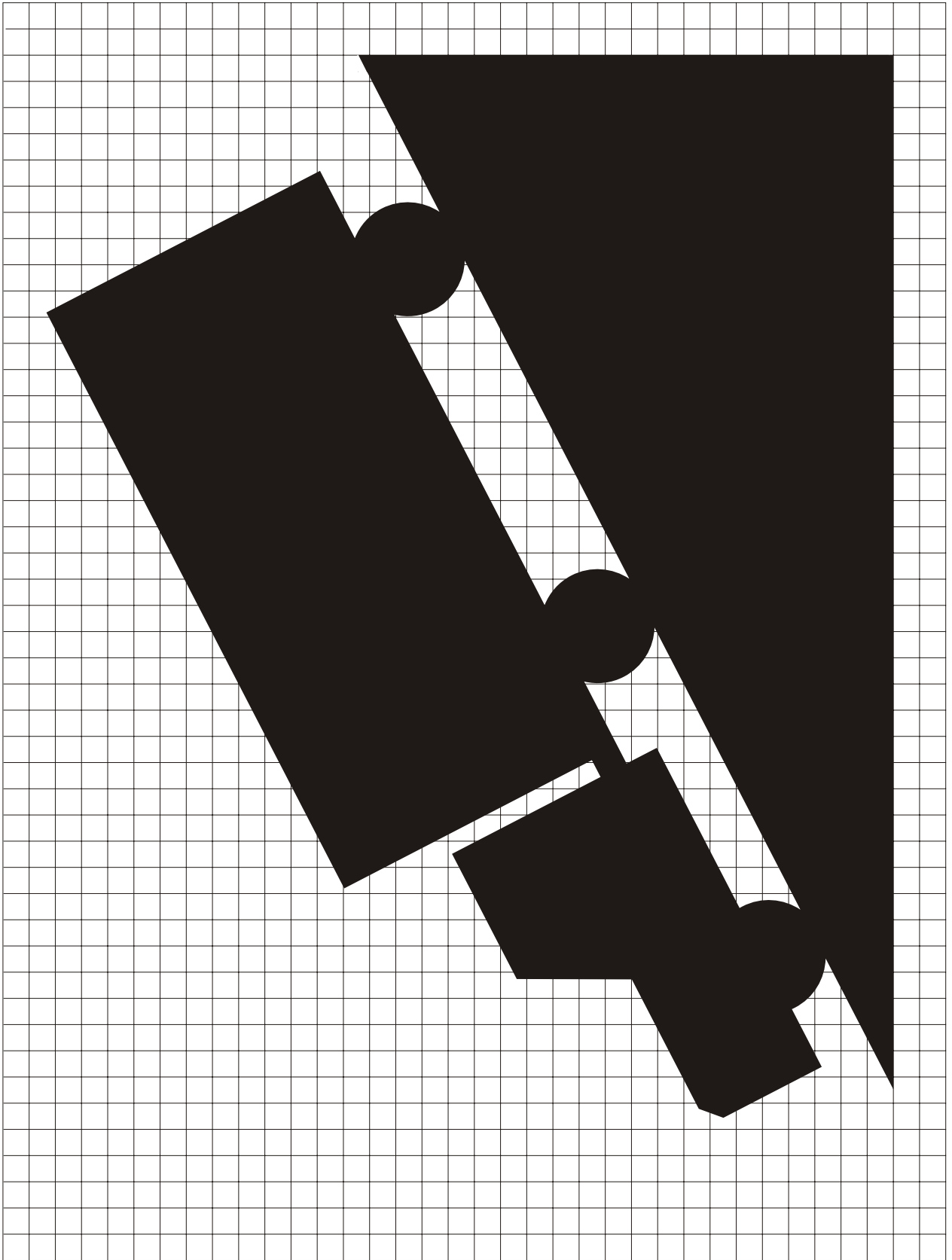

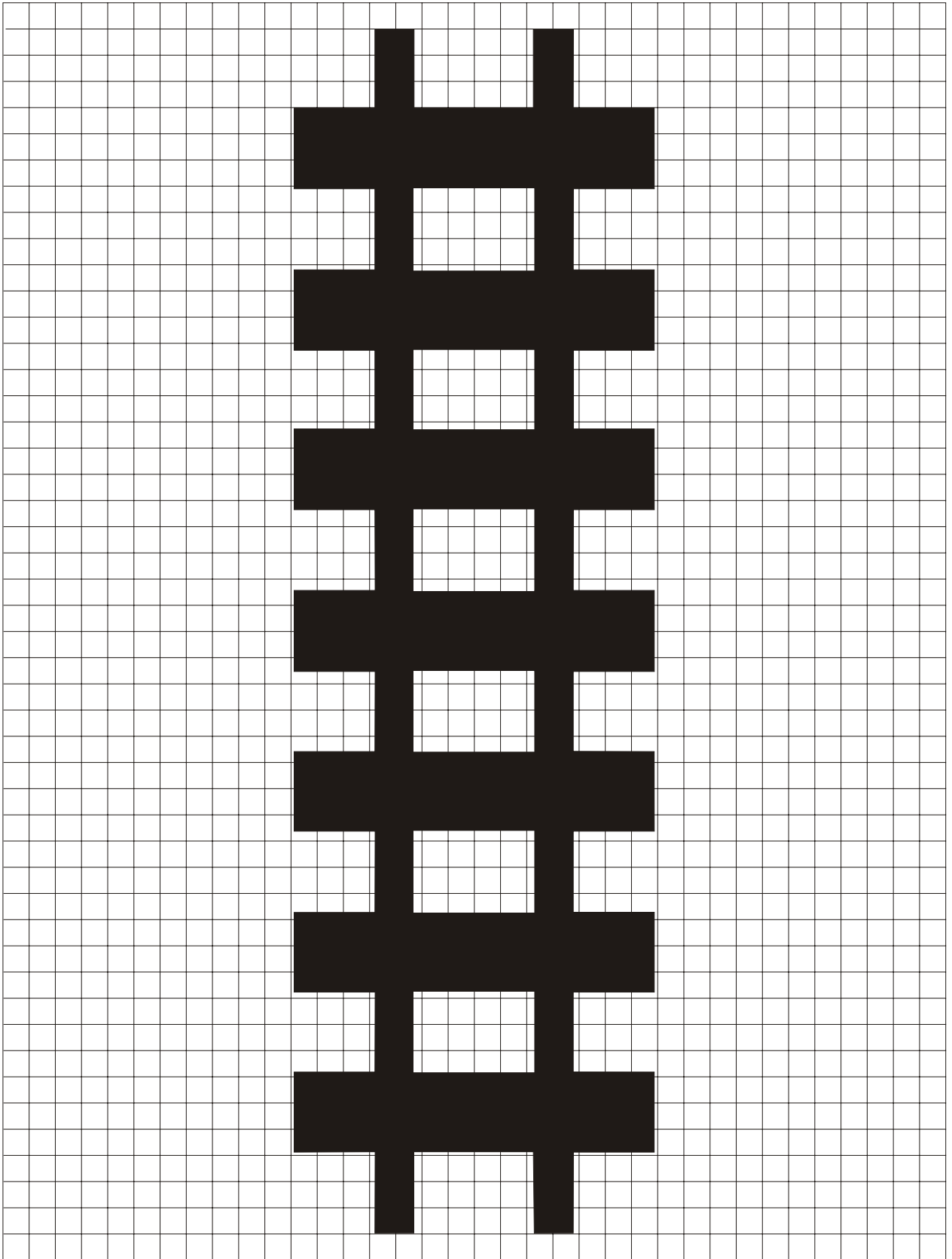

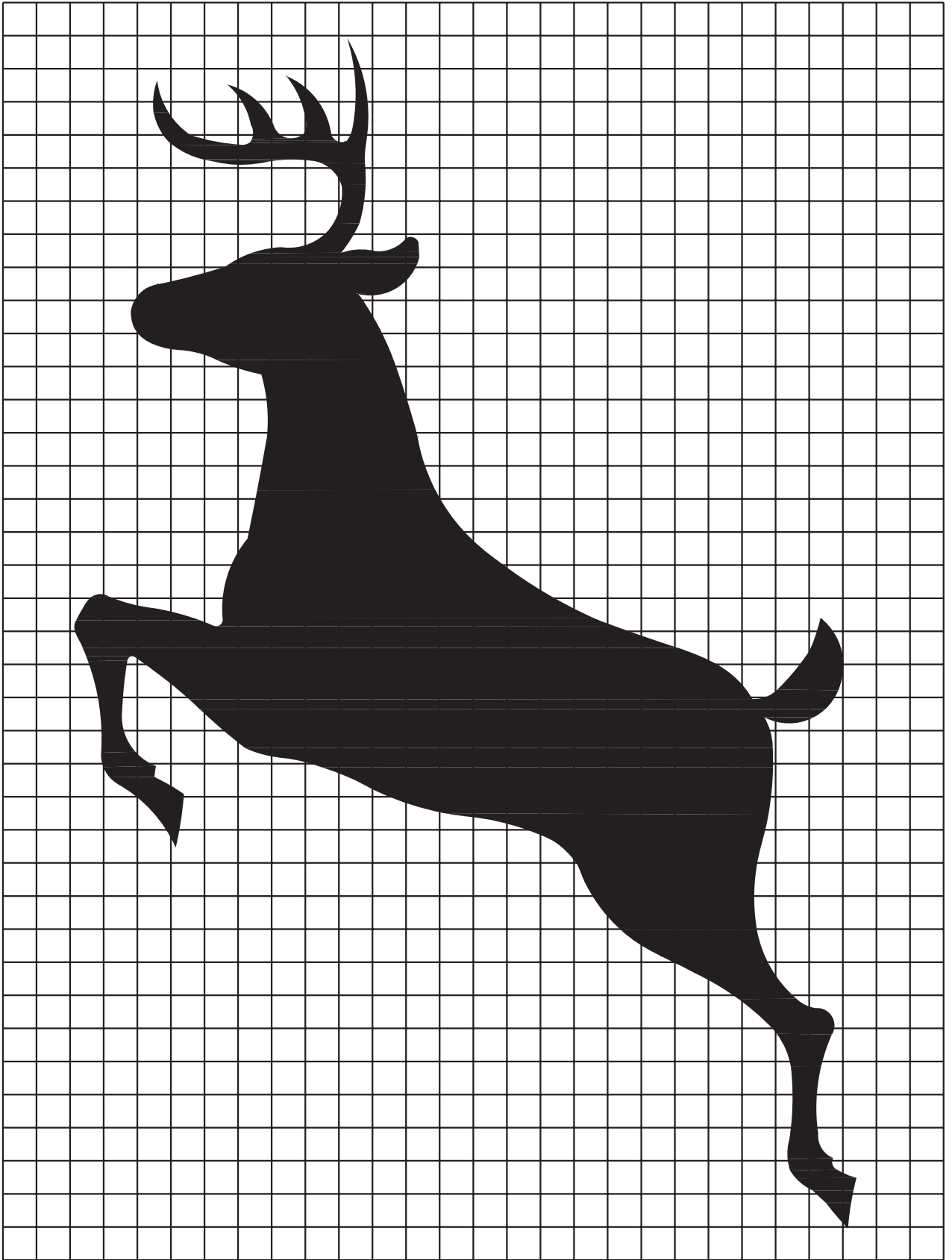

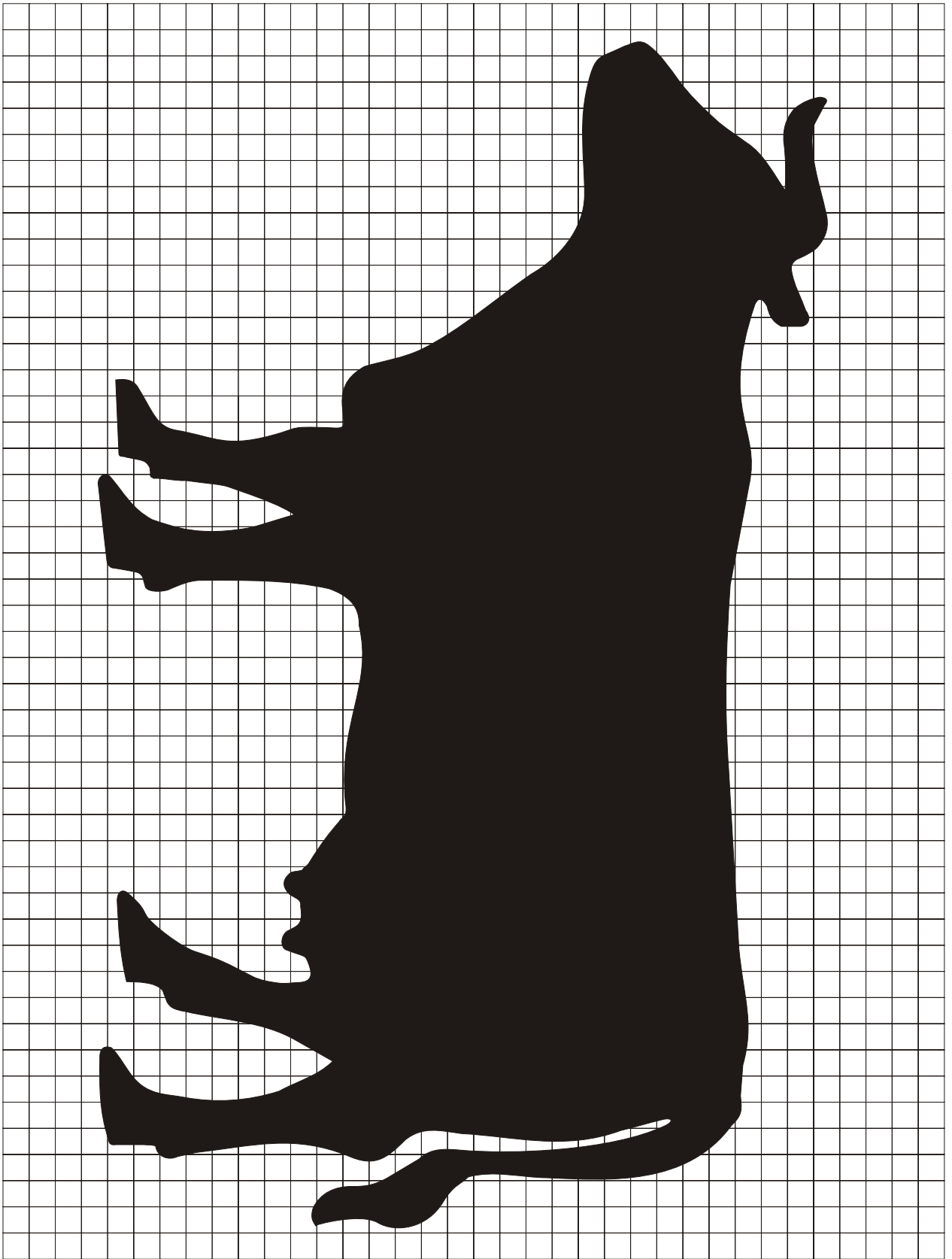

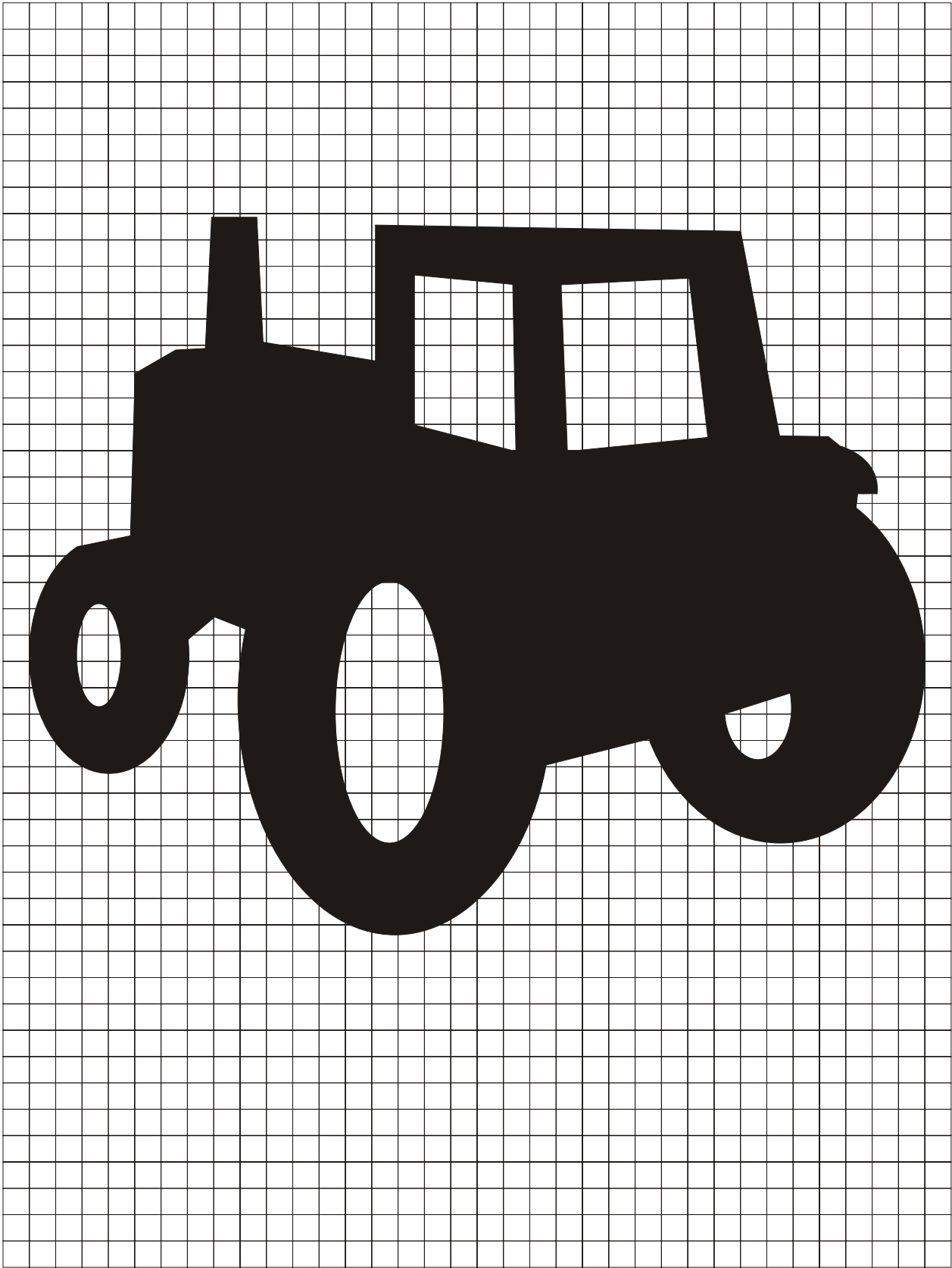



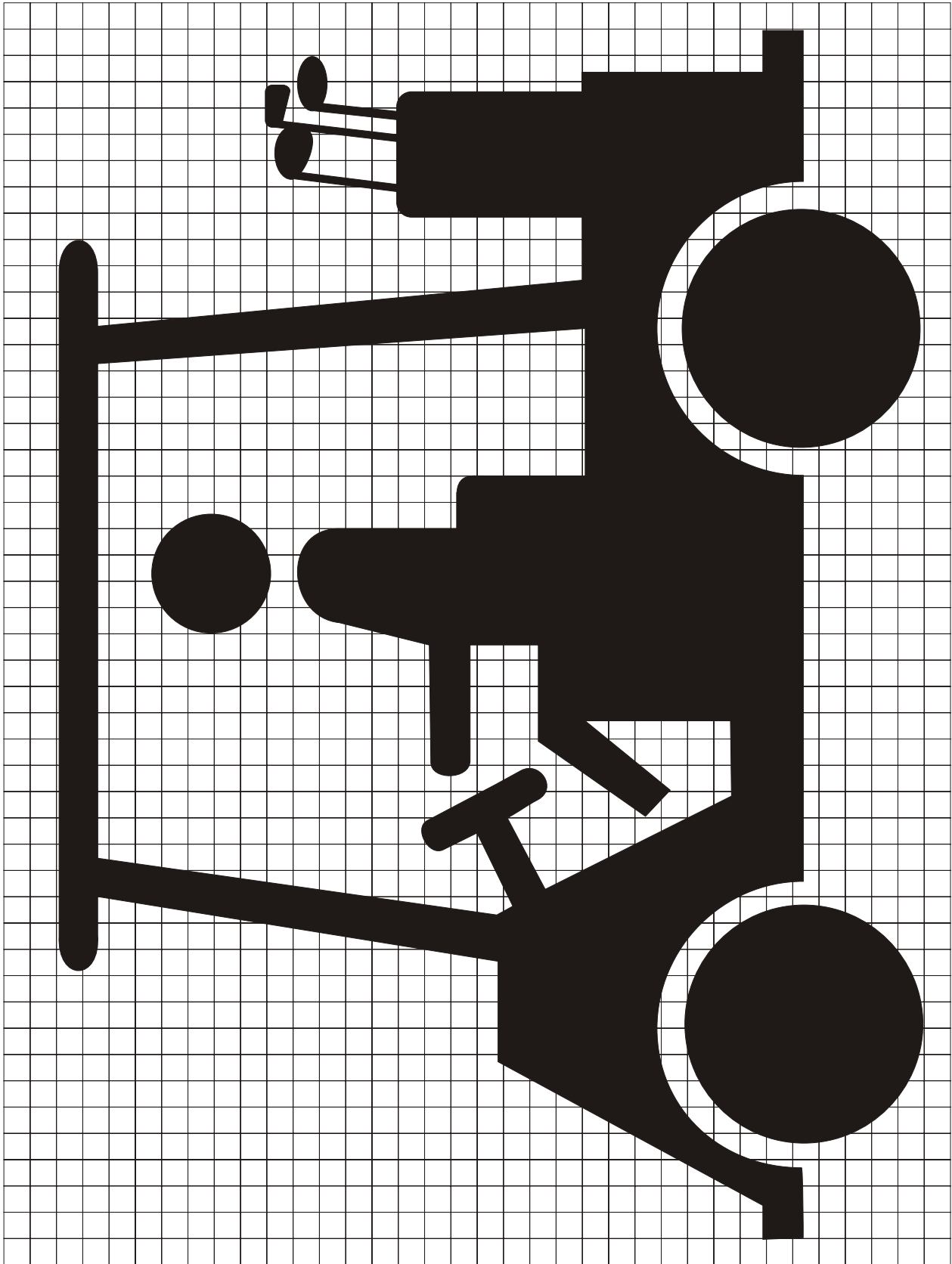

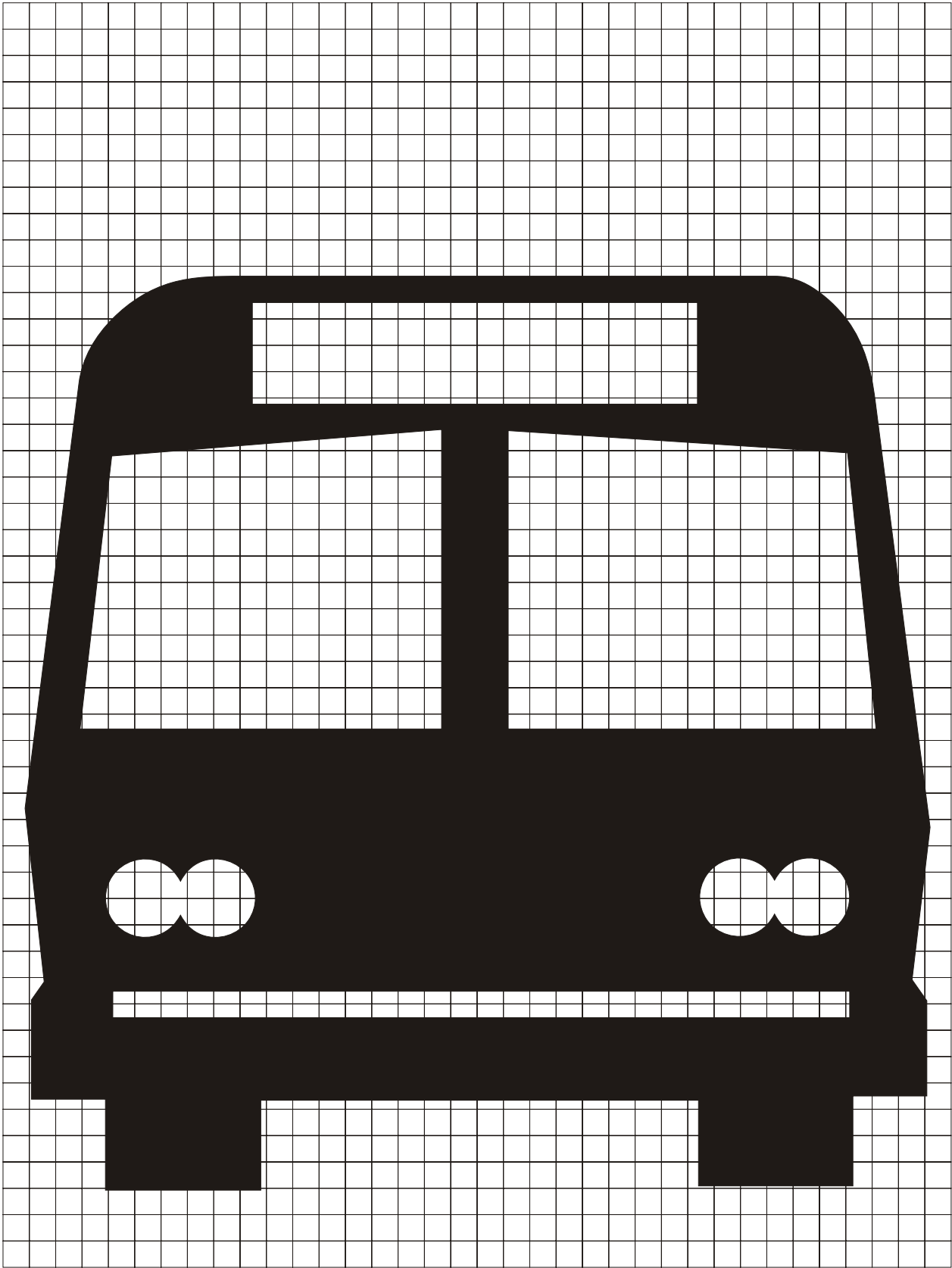

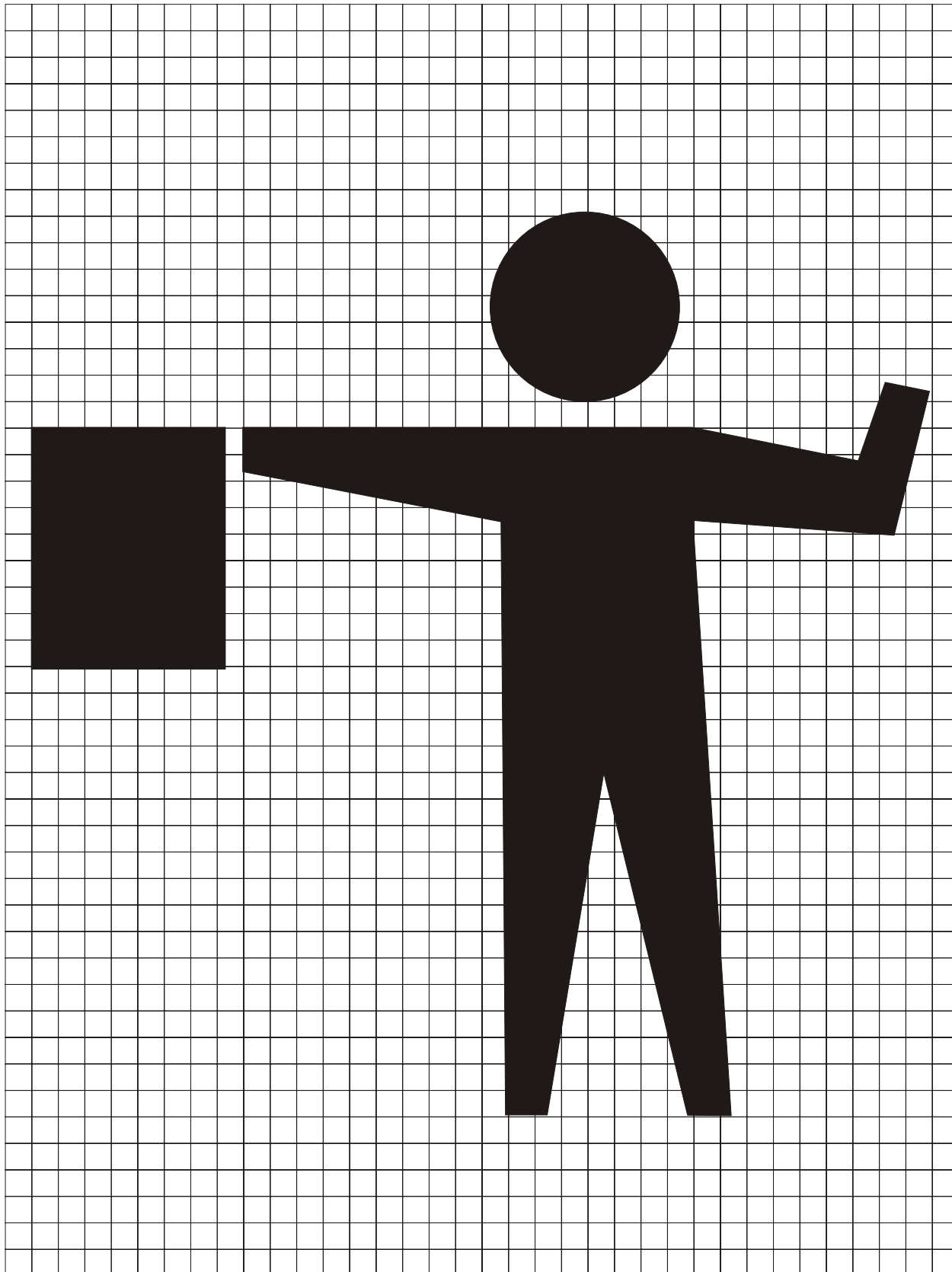

**National
Font**

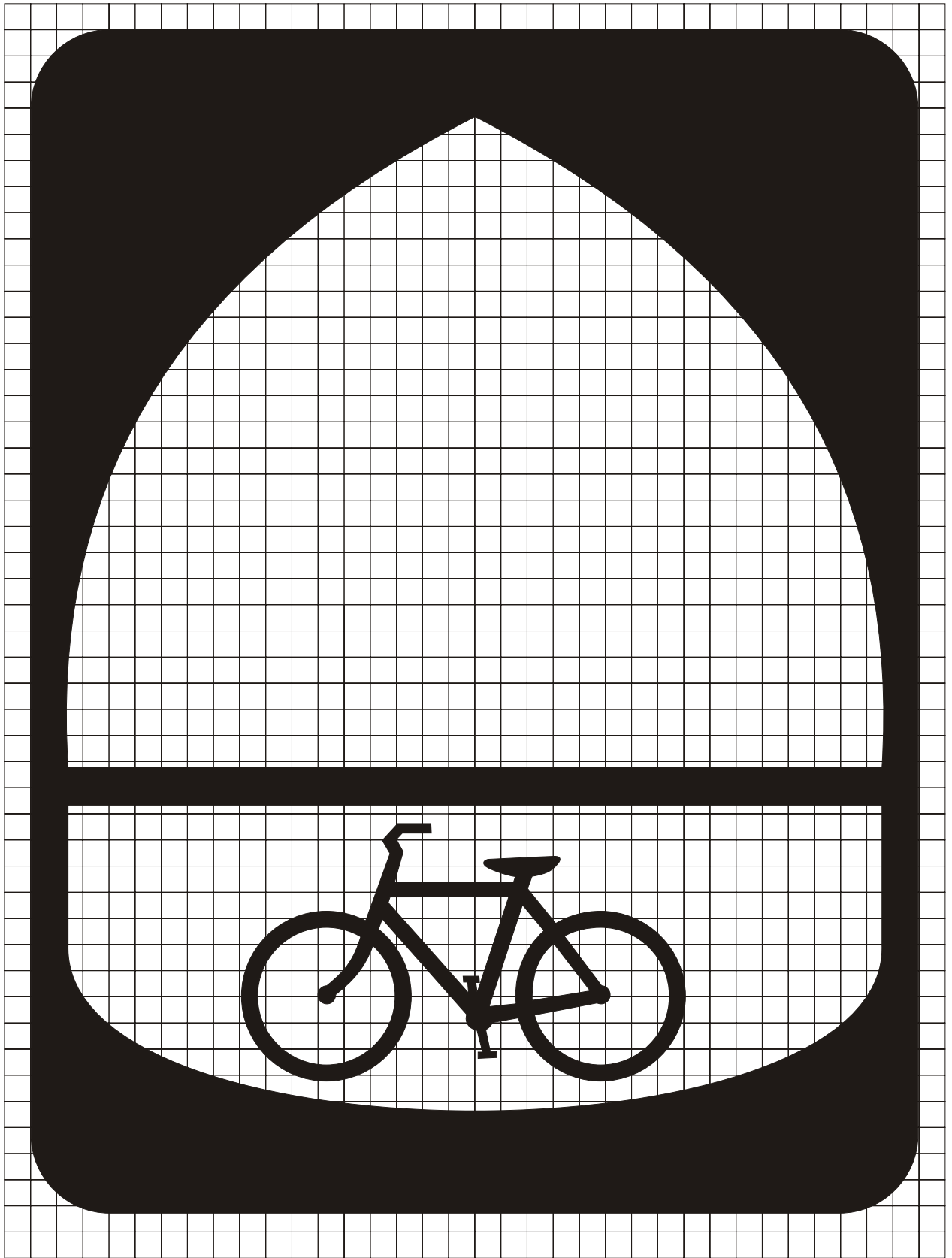

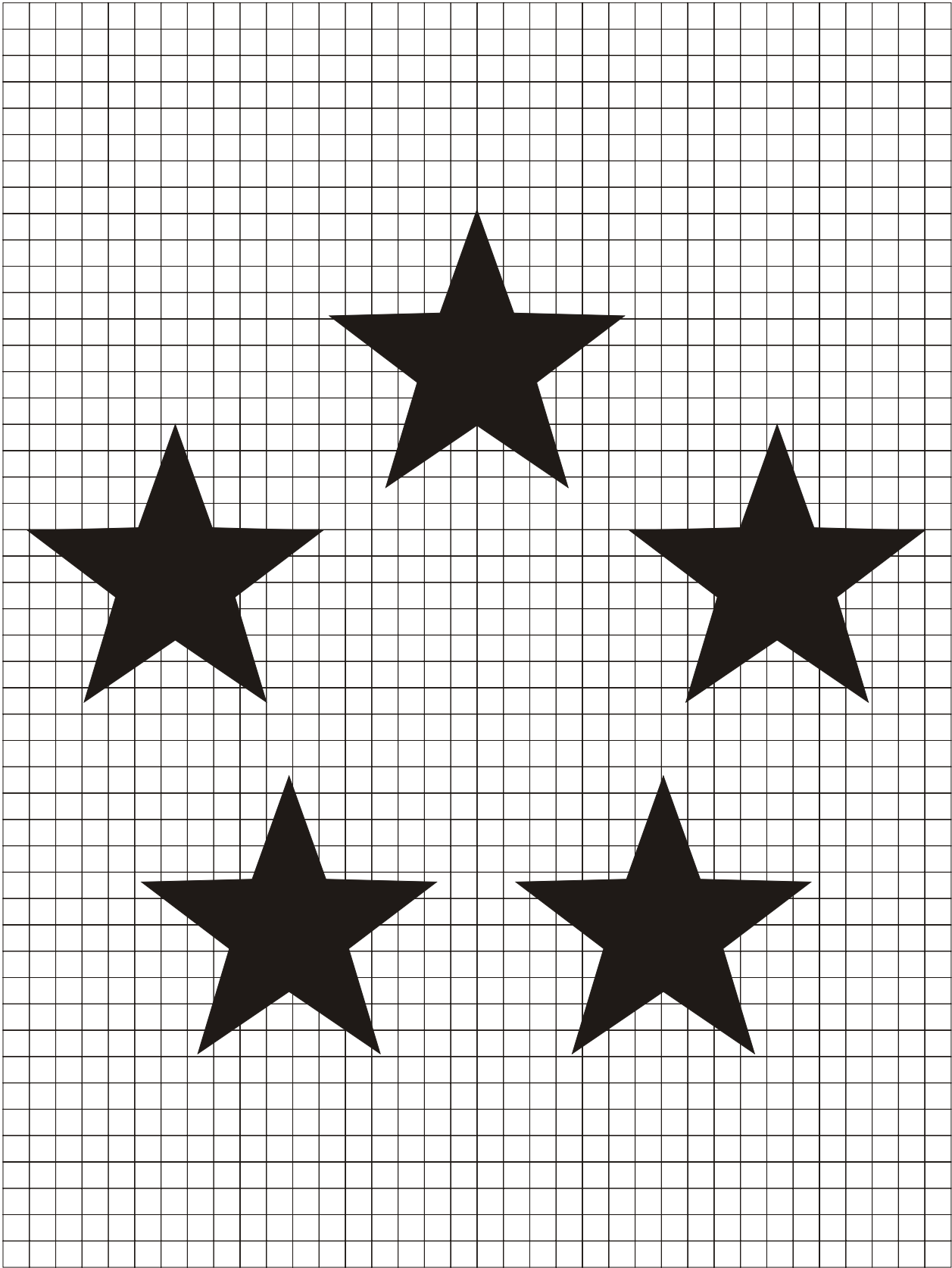

DISSEMINATION INTEGRATING SYSTEMS

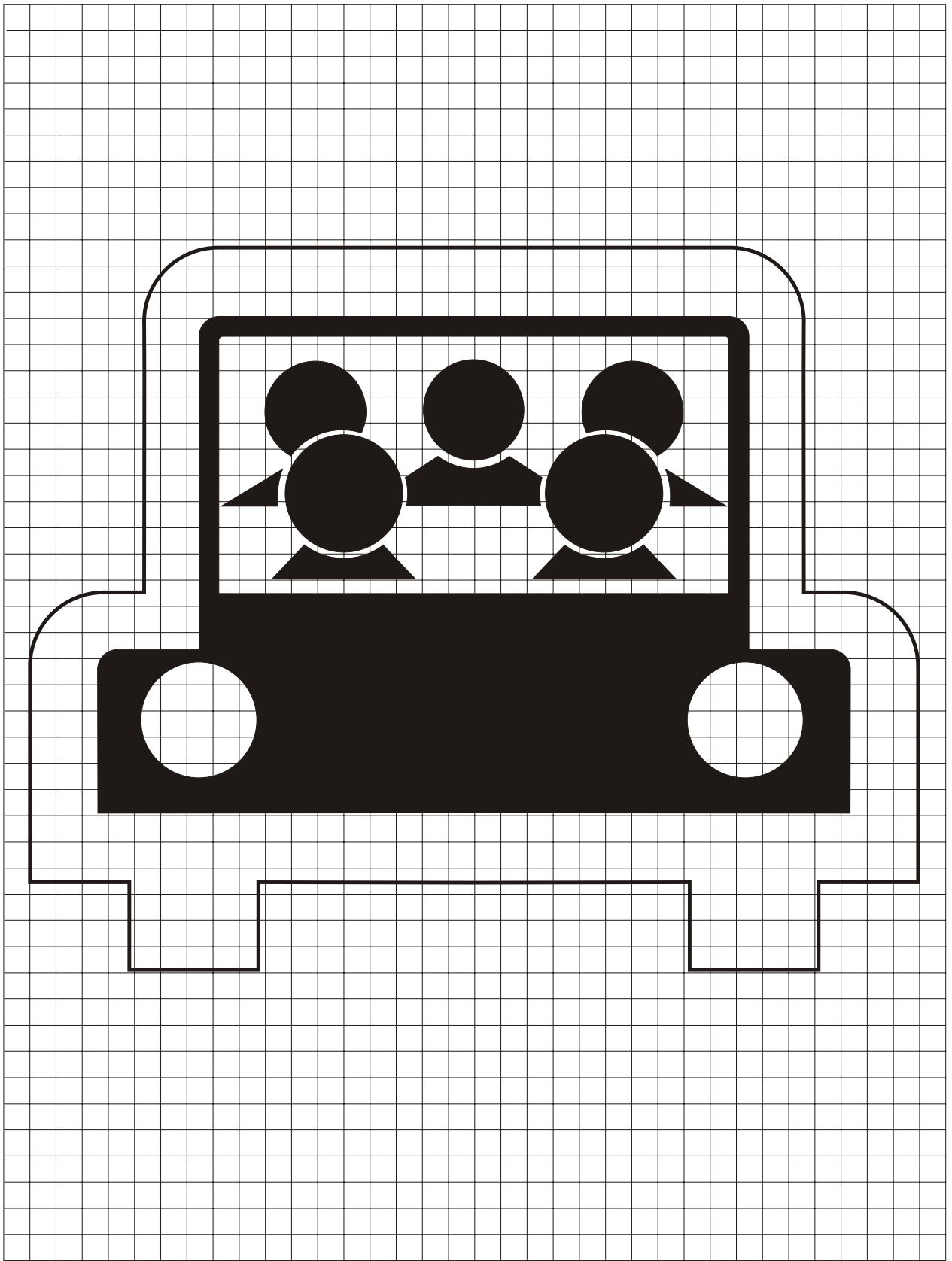

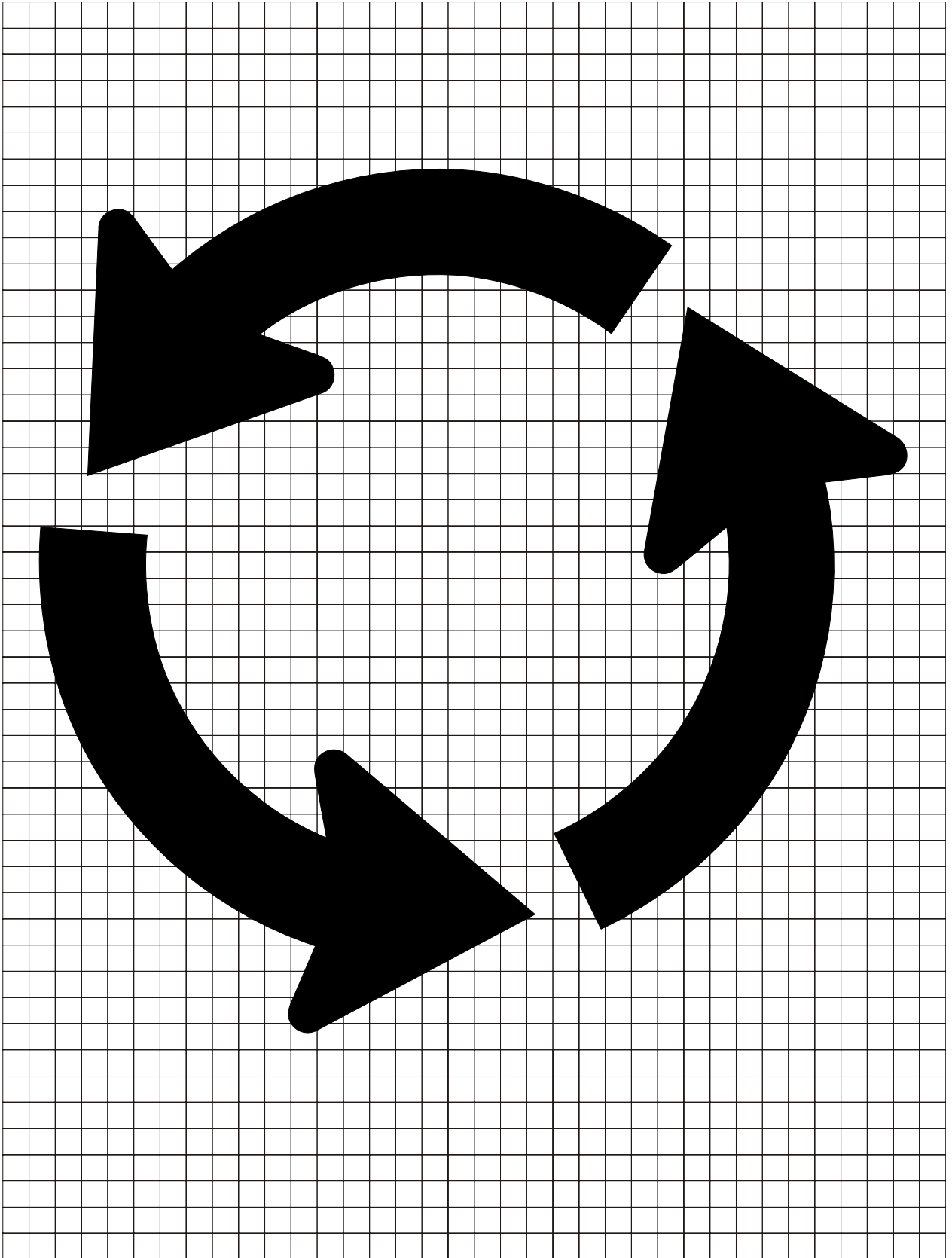



LITTER

BARREL

1000 FT

SAVE TAXES

USE

LITTER

BARREL

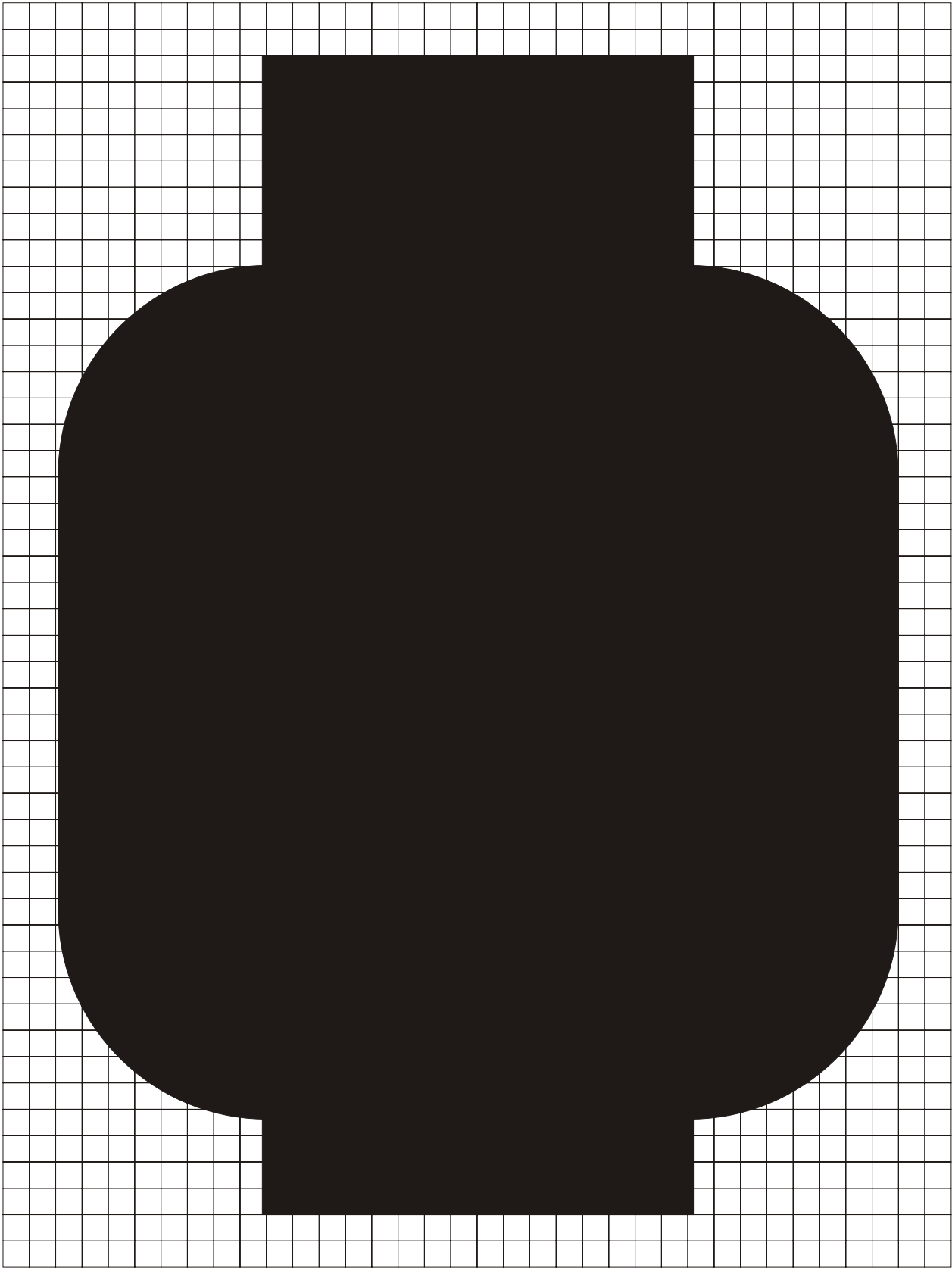



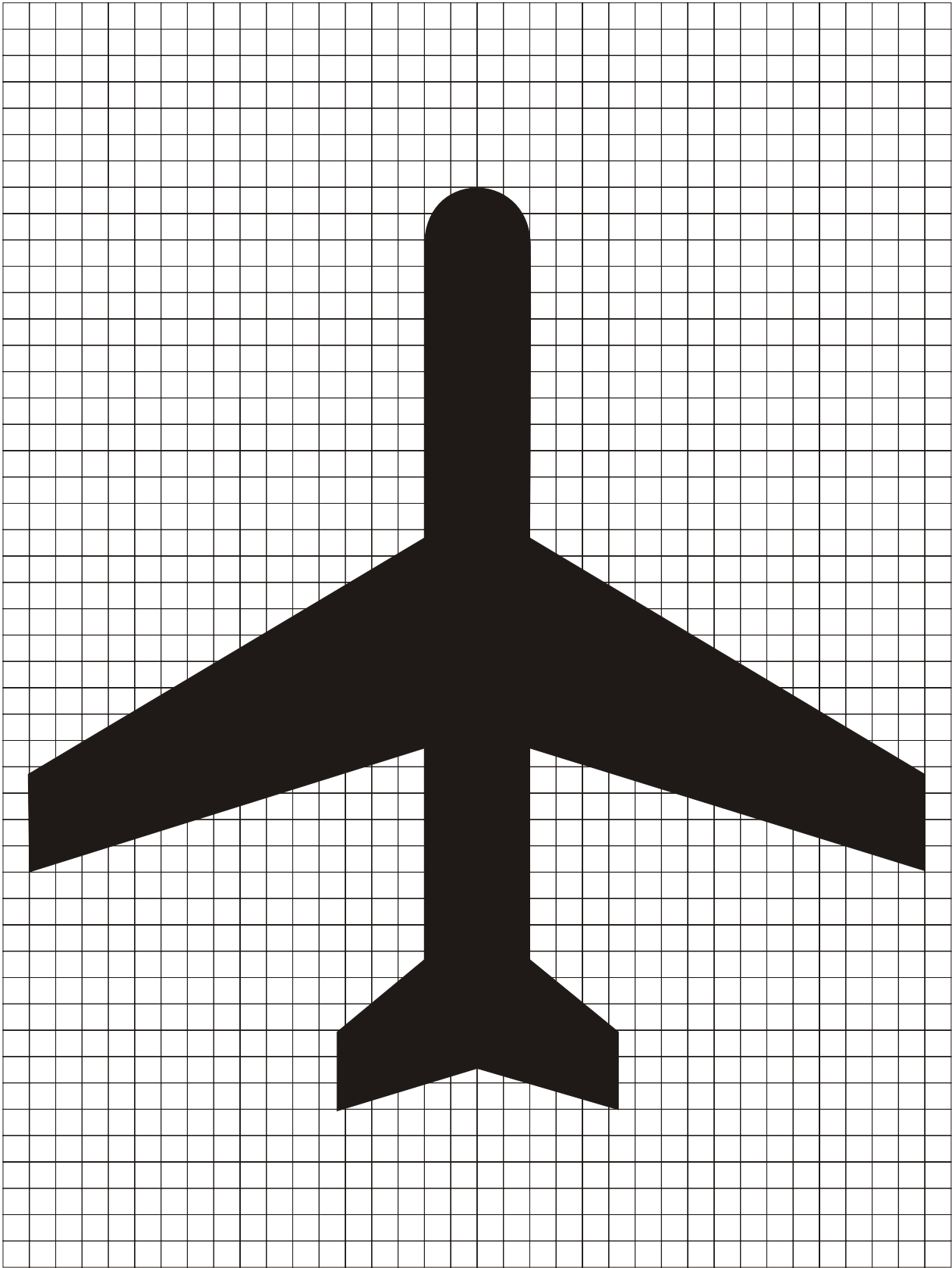

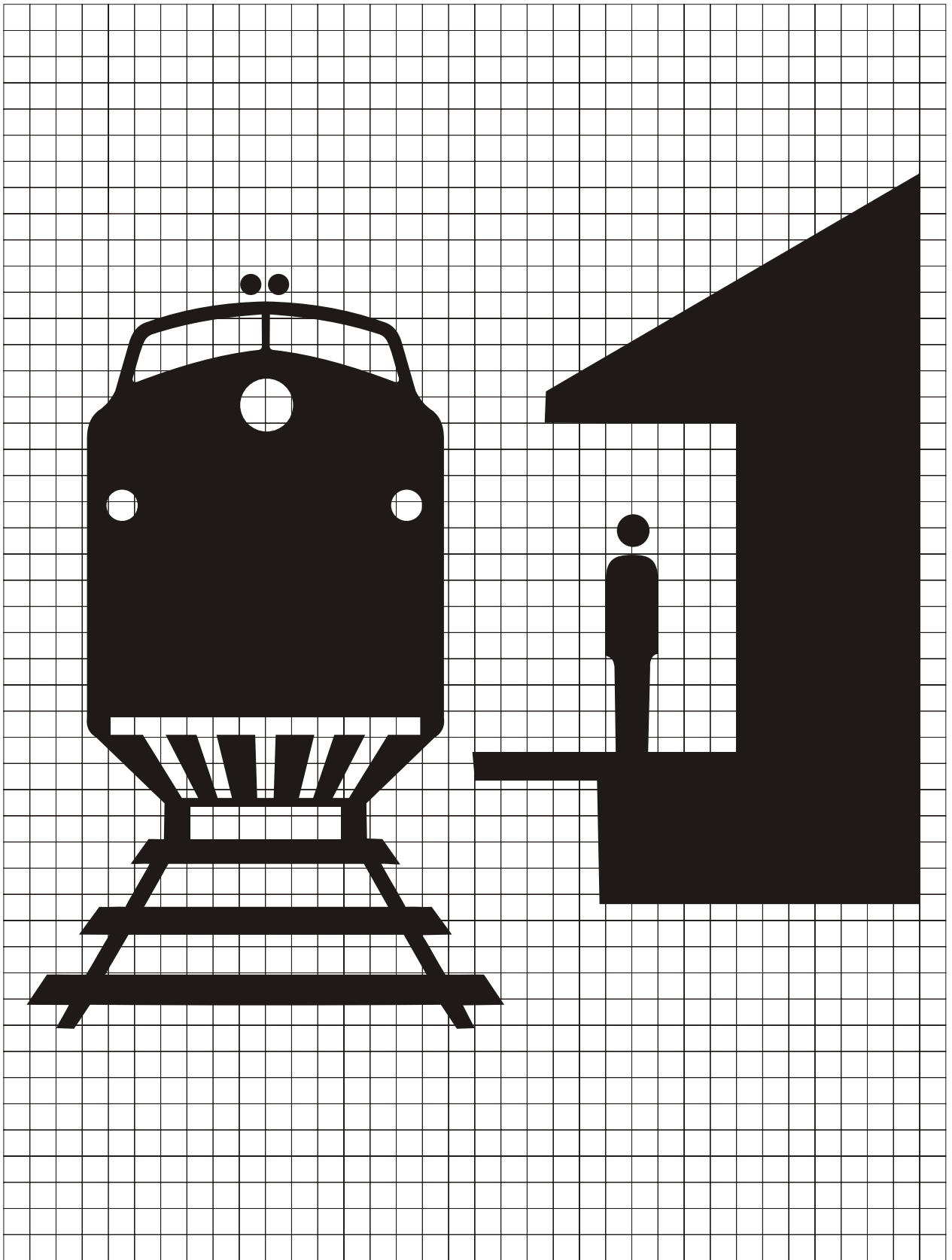

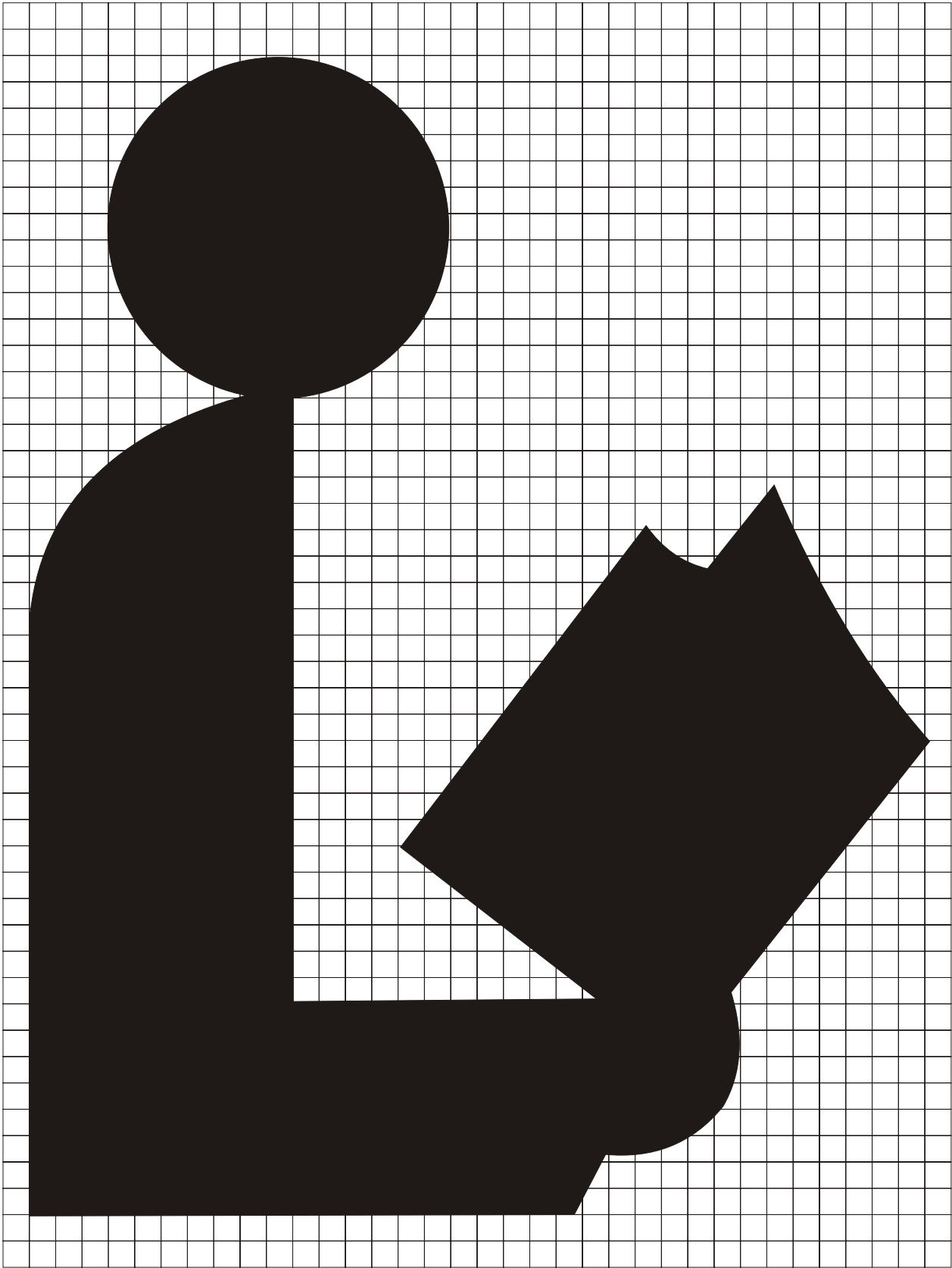

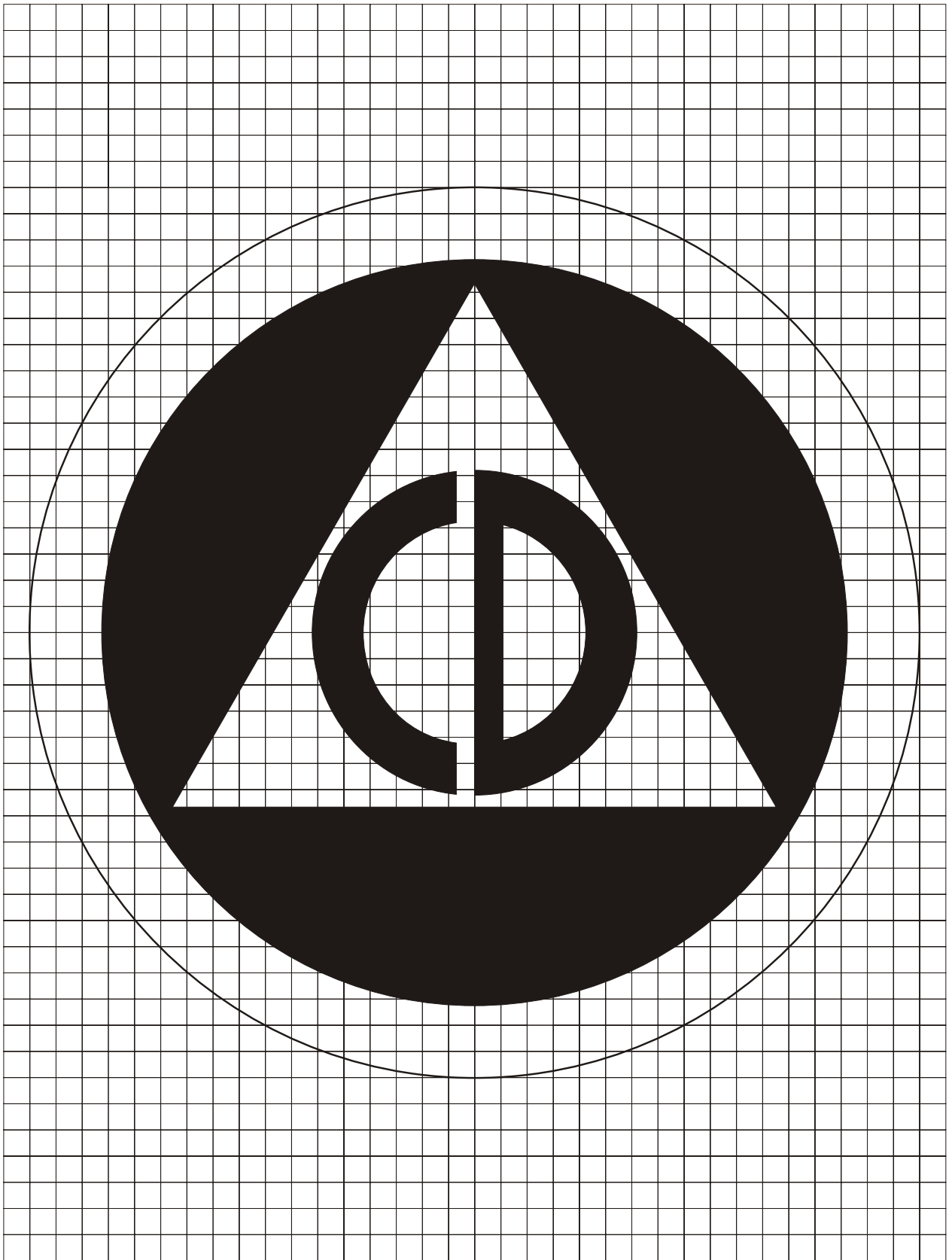

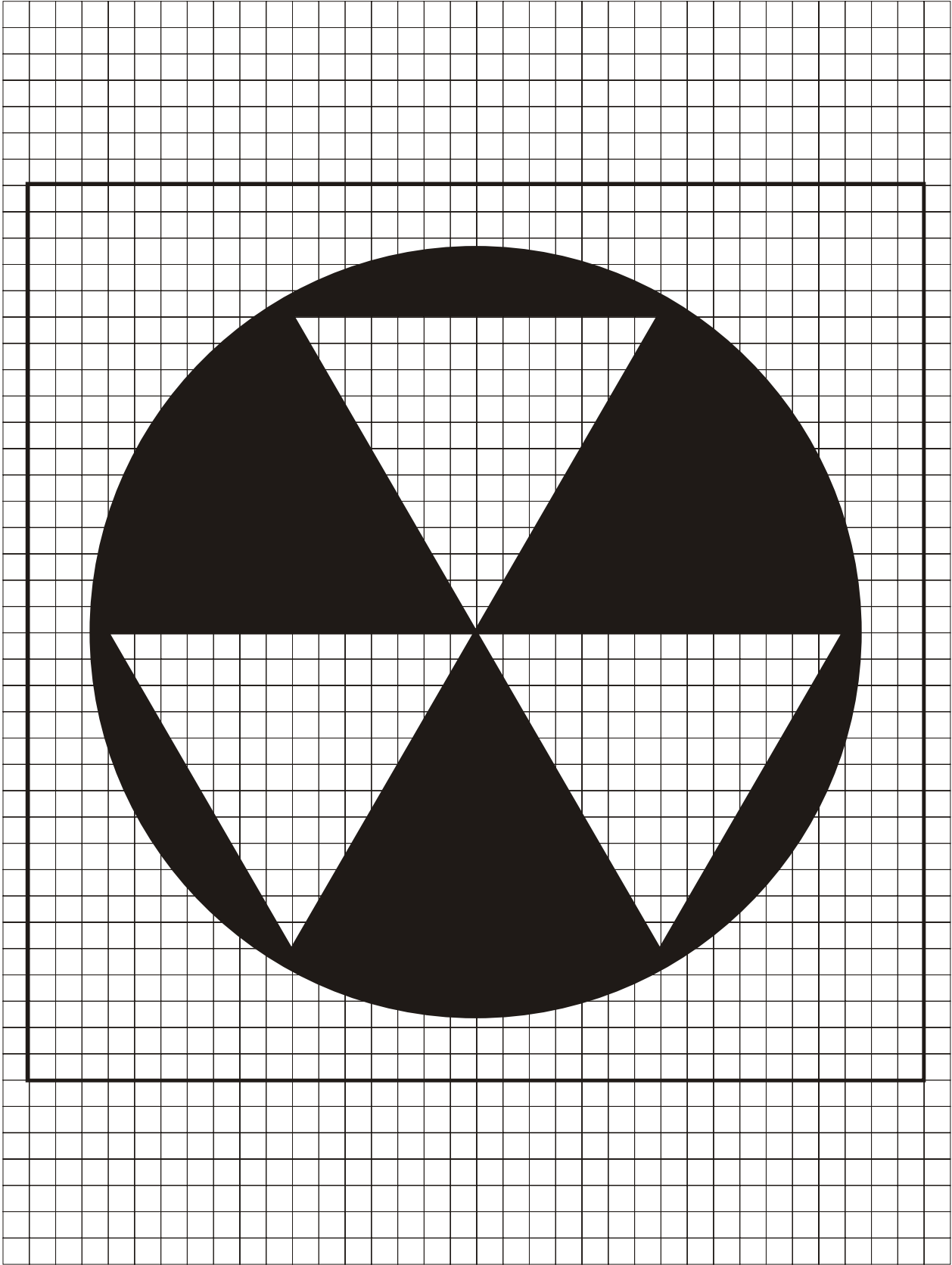

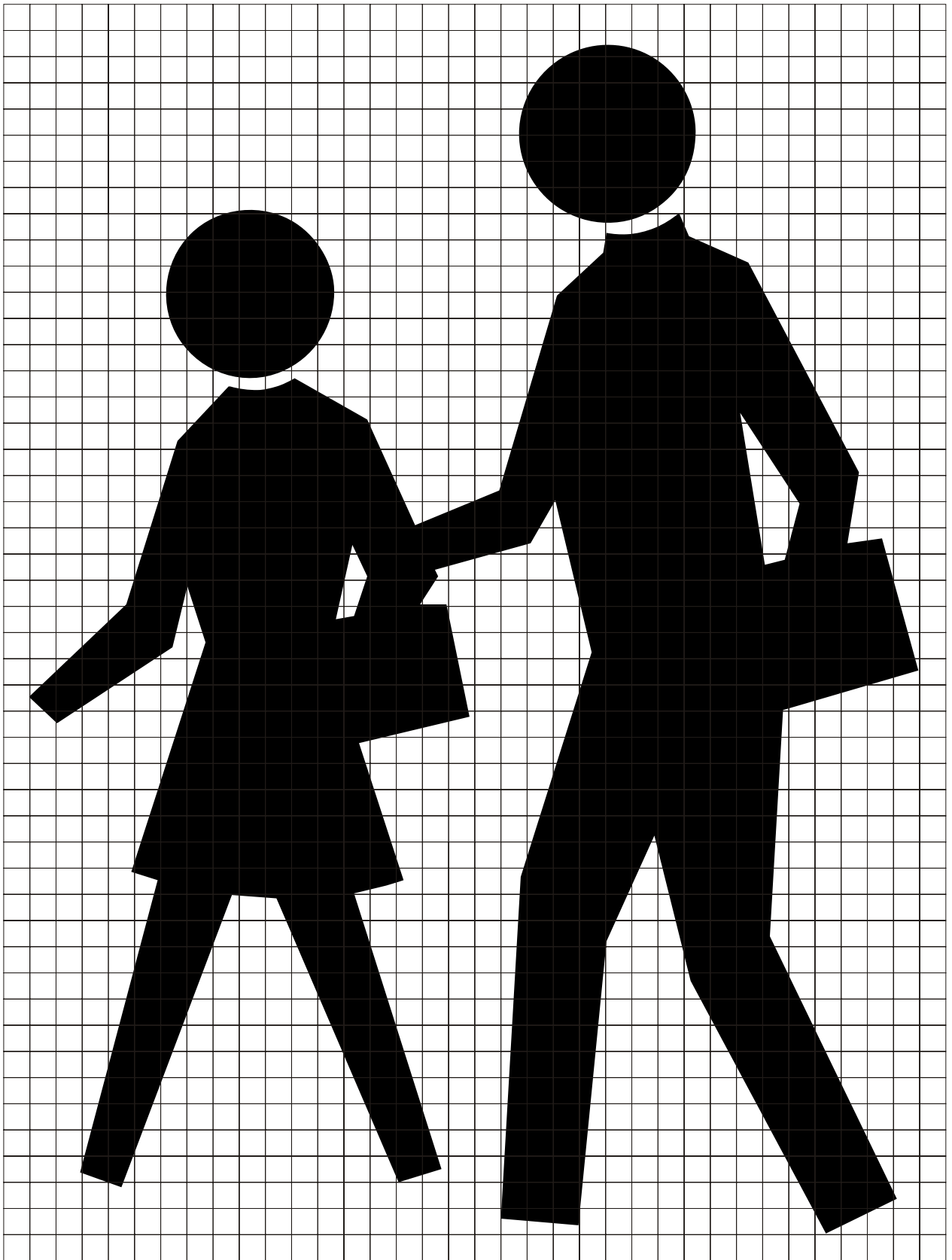

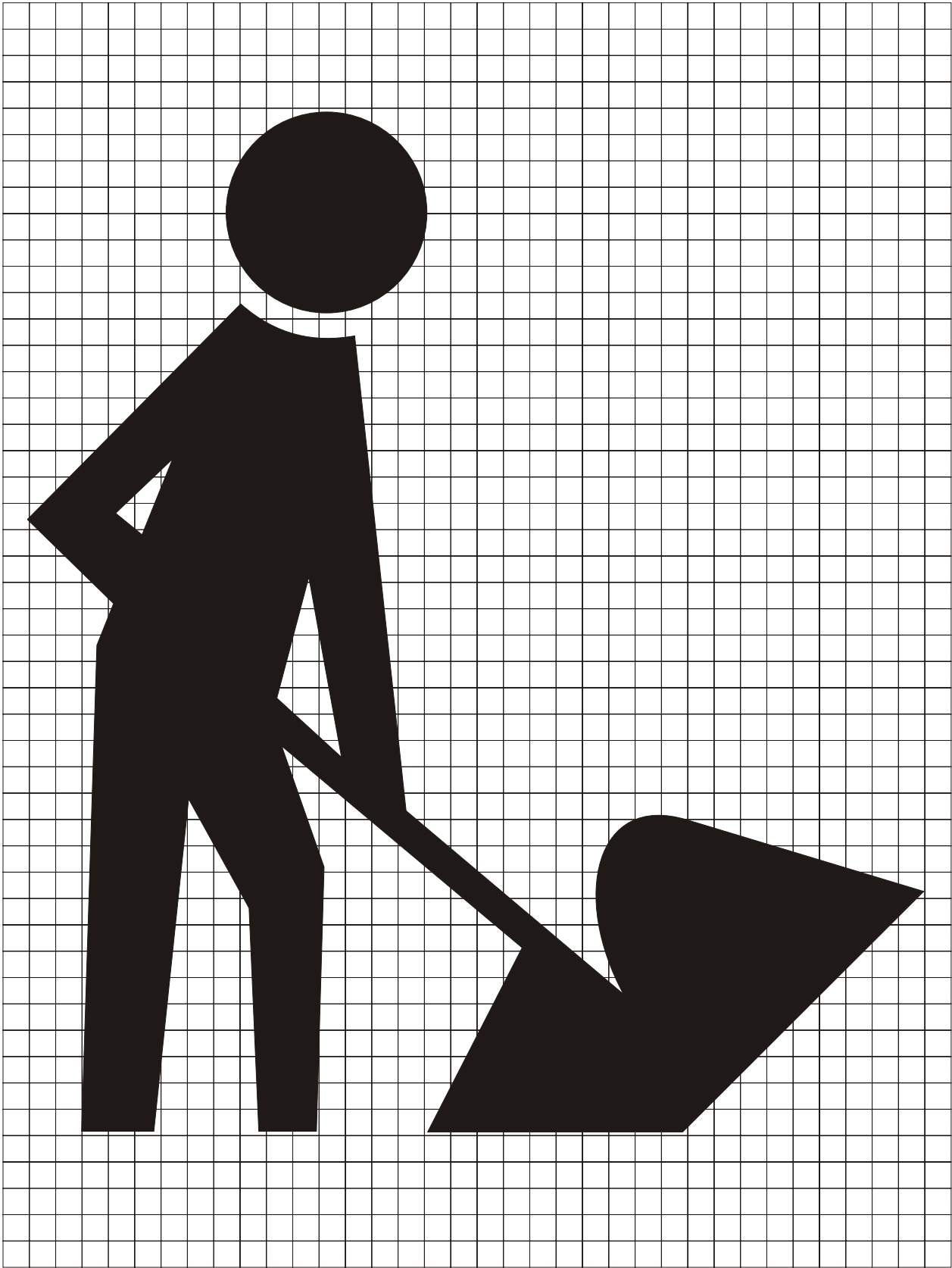



6-59.1

TEXAS SYMBOL

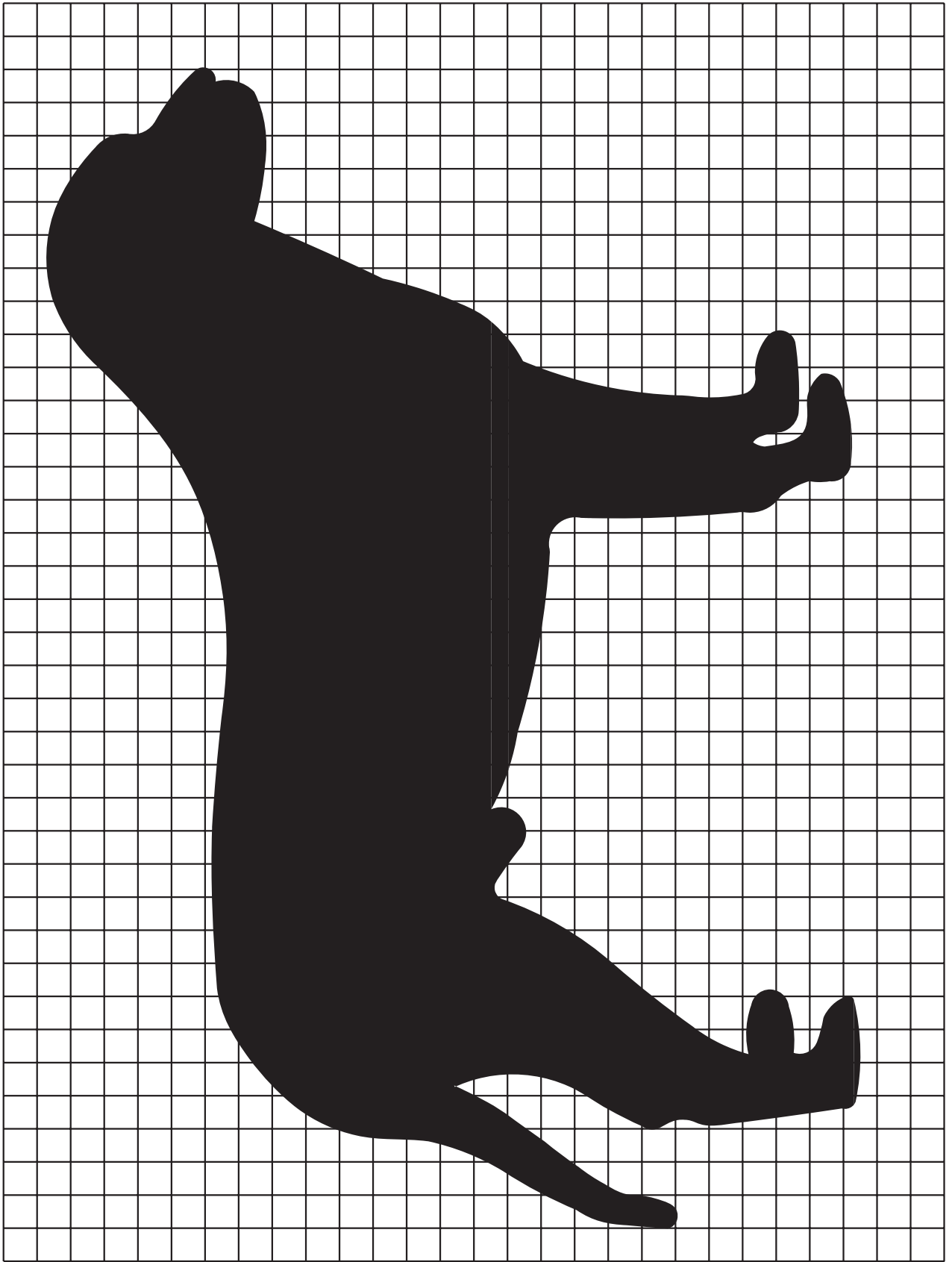

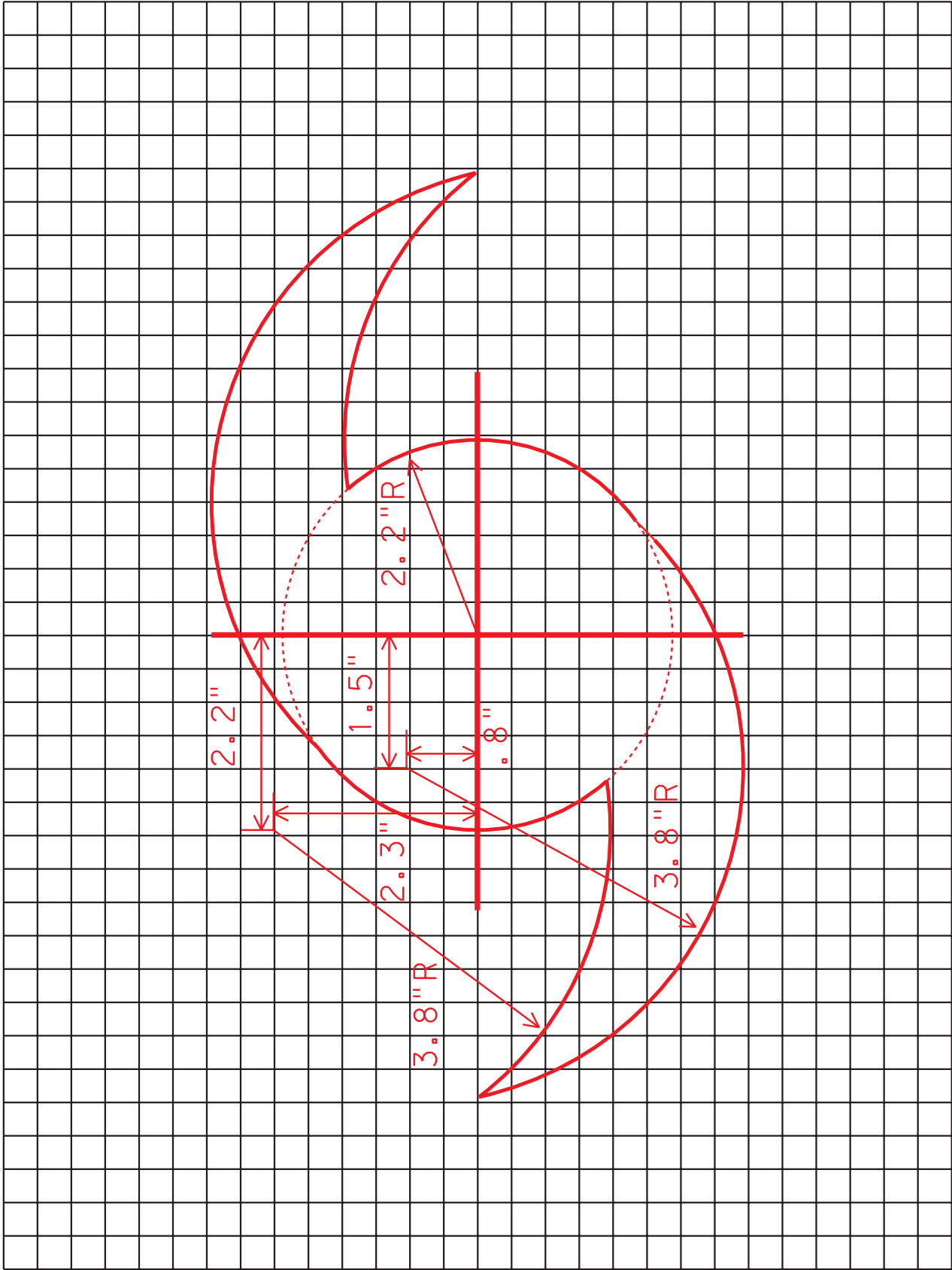

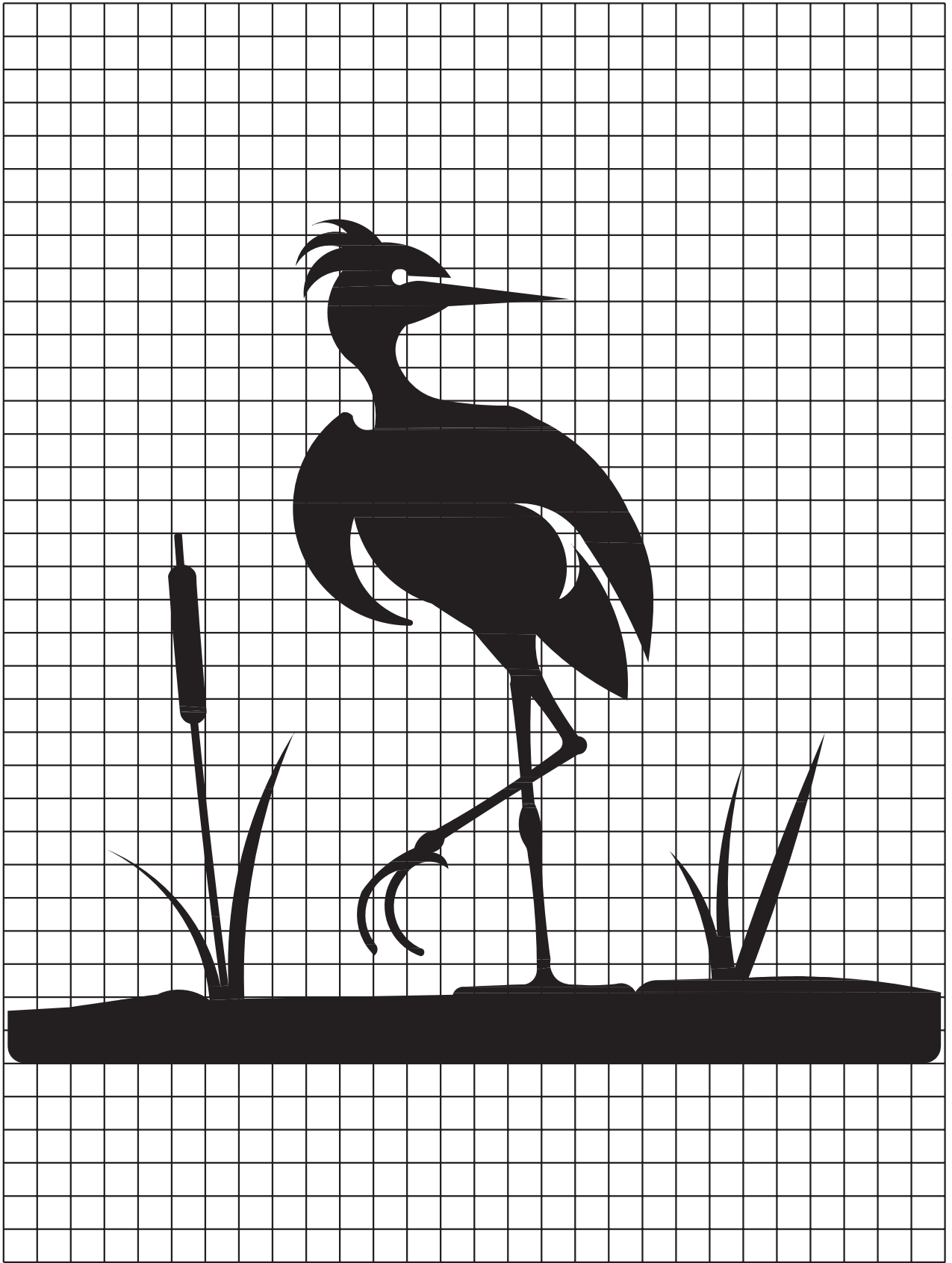

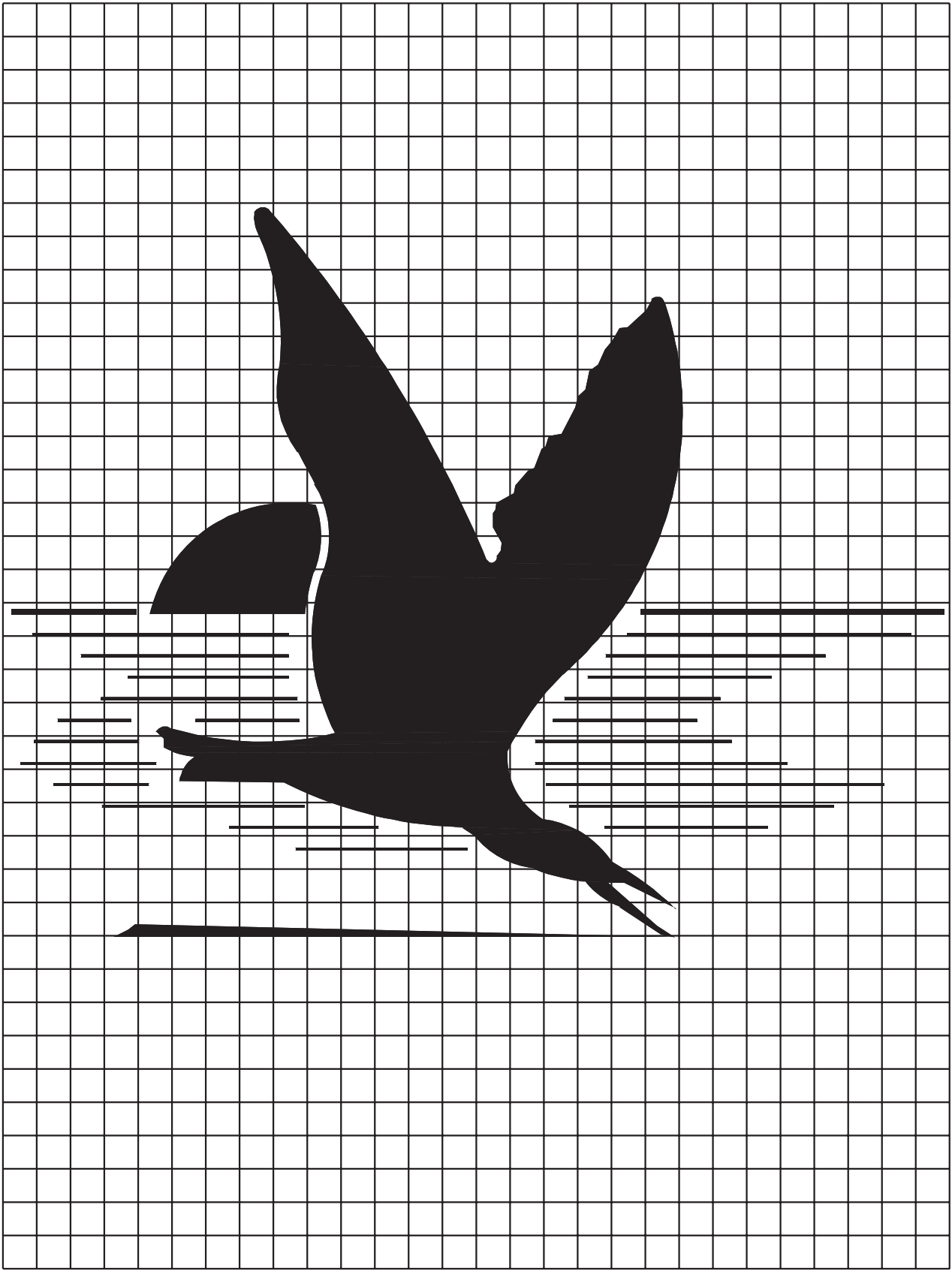

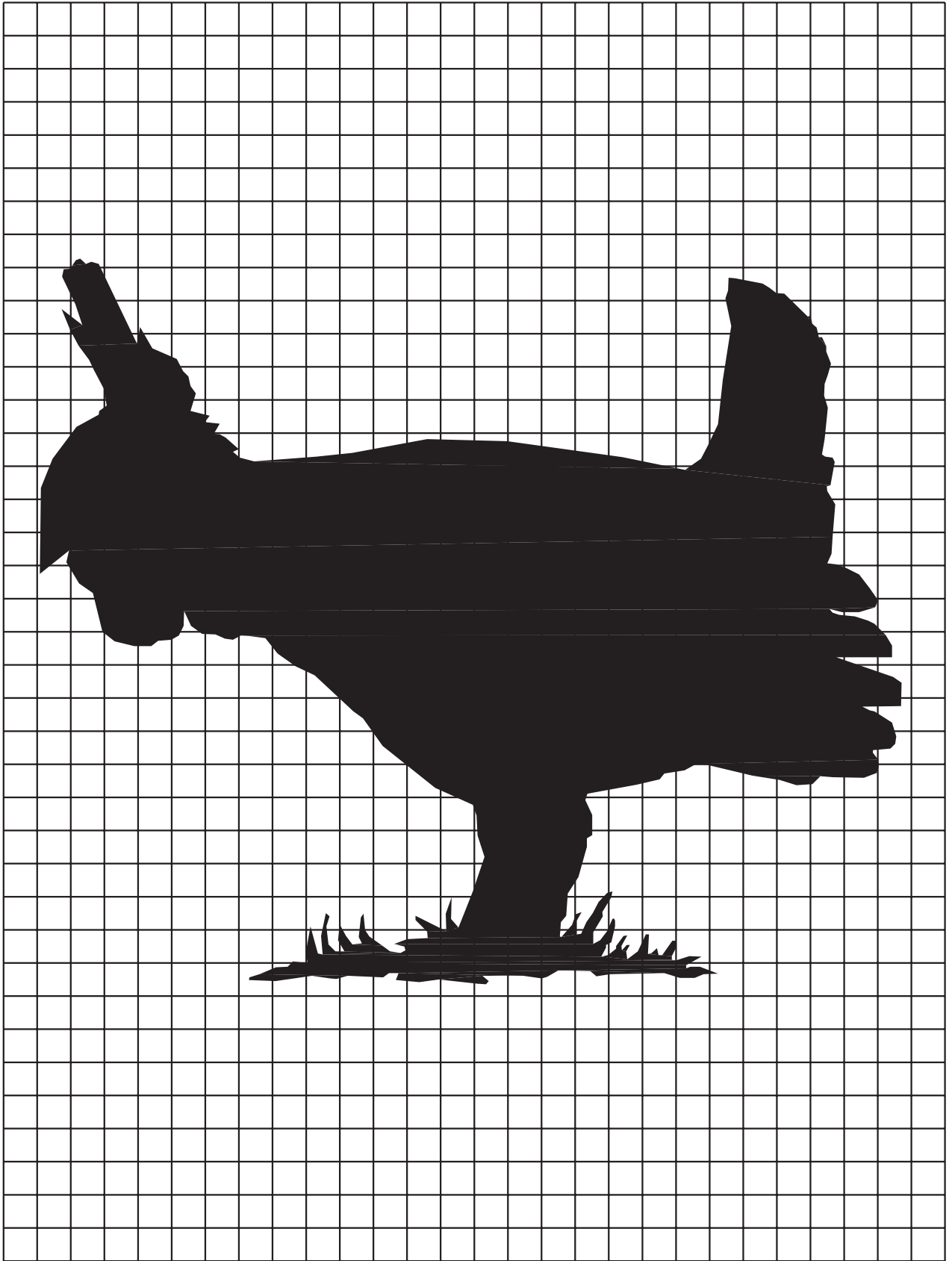

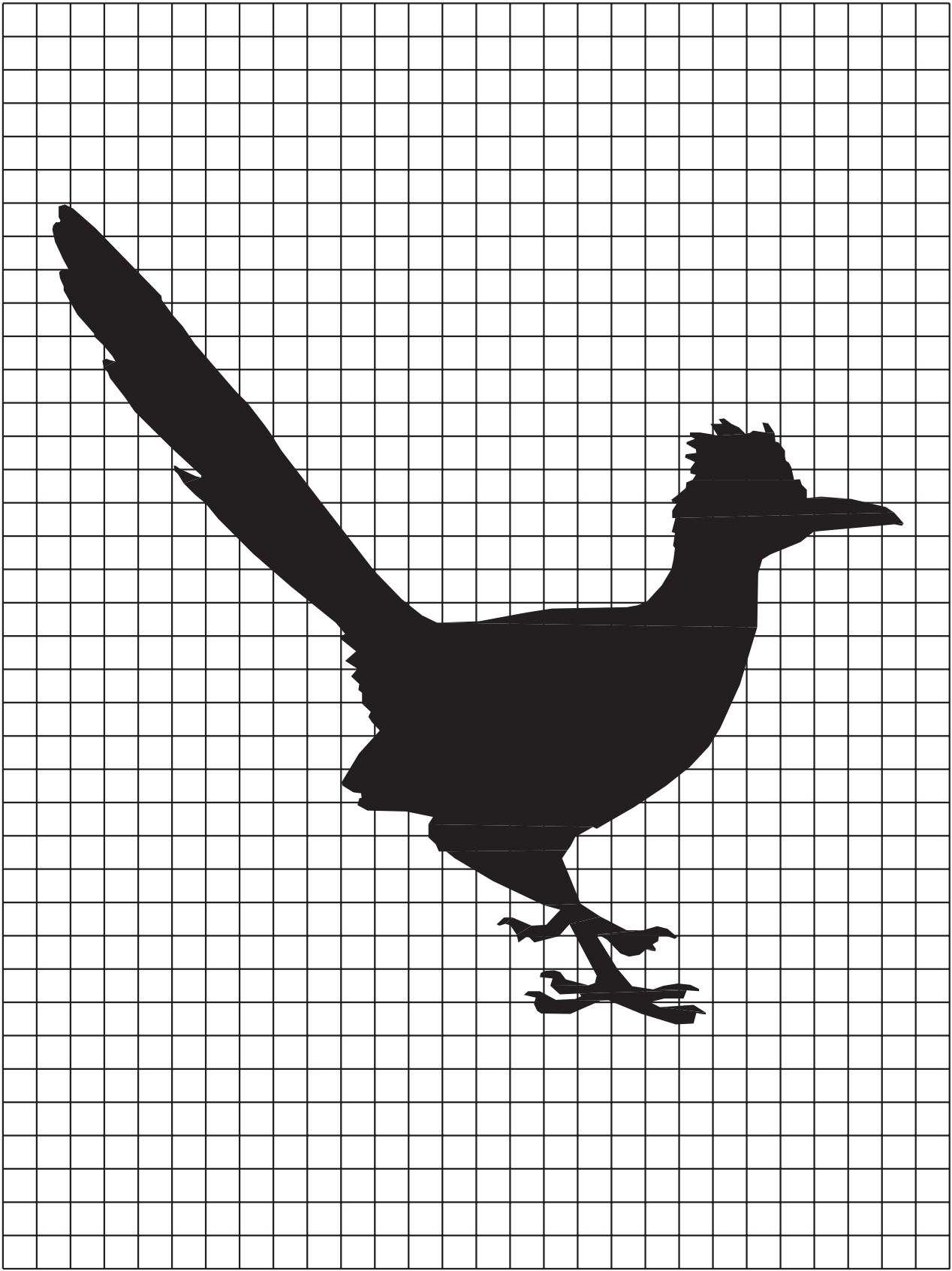

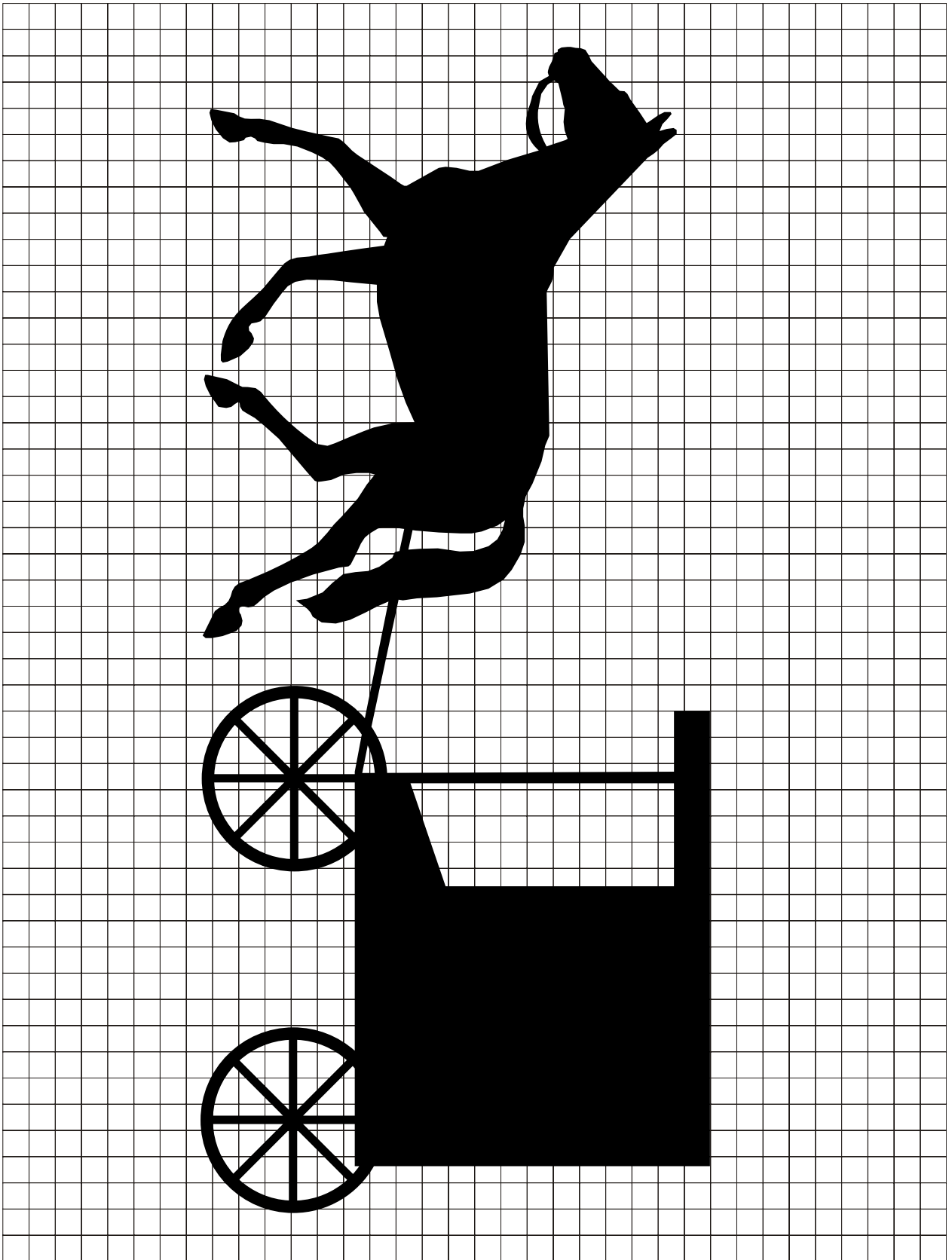

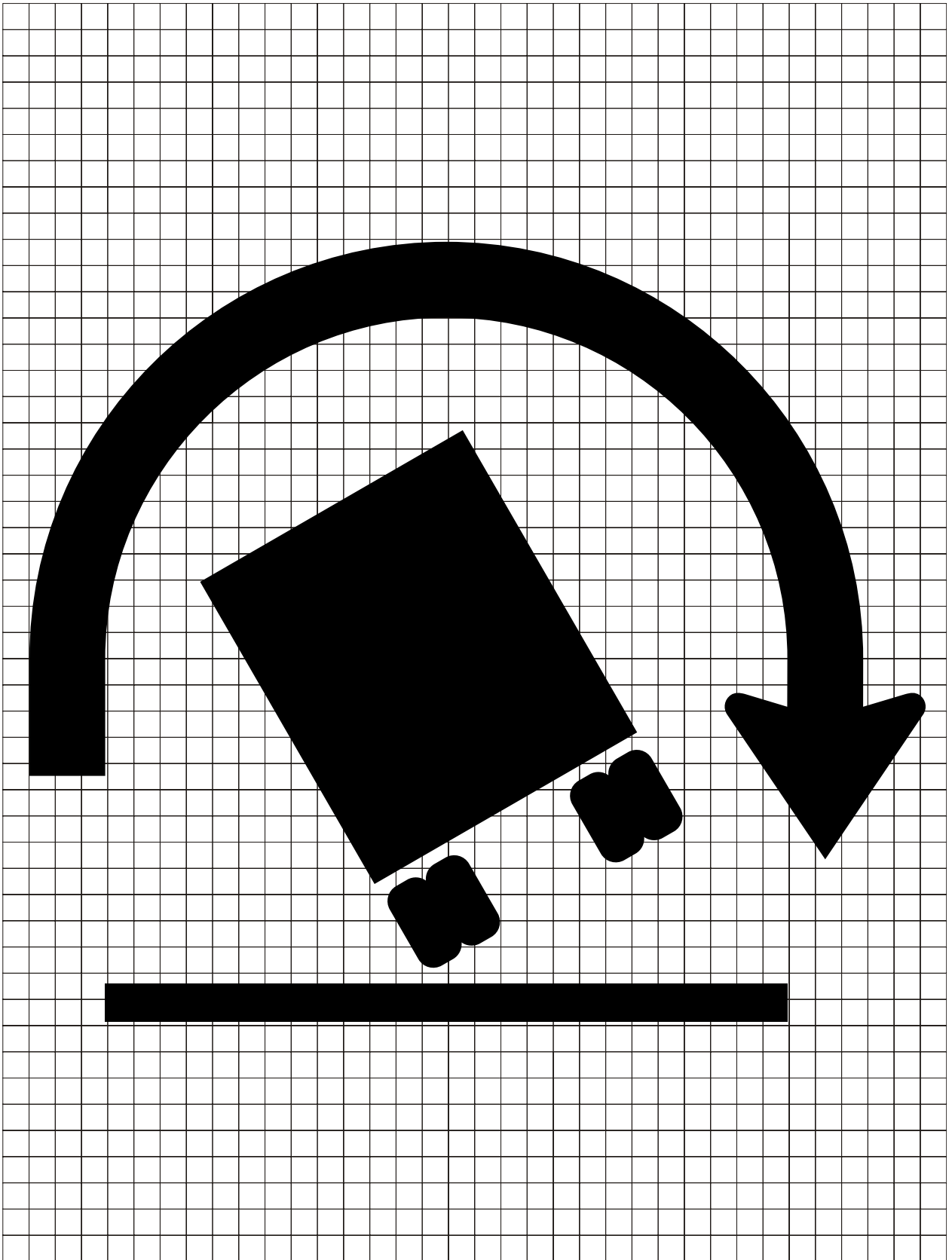

FOLLOW THE LEADER

